



ACQUISITION OF NORTHPARKES

Investor Presentation
05 December 2023

NOT FOR RELEASE OR DISTRIBUTION IN THE UNITED STATES

IMPORTANT NOTICES (1/3)

The following disclaimer applies to this investor presentation and you are advised to read this carefully before reading or making any other use of this presentation or any information contained in this presentation.

This presentation has been approved by the Board of Directors of Evolution Mining Limited ("**Company**" or "**Evolution**" or "**EVN**").

This presentation has been prepared by and is issued by Evolution and is dated 5 December 2023 in relation to:

- The Transaction, comprising:
- Evolution's proposed acquisition of:
- 100% of the shares in CMOC Metals Holdings Limited a company incorporated under the laws of Hong Kong, ("**CMOC Metals**"), being the 'seller' under the Triple Flag Streaming Agreement and the assumption of the guarantee provided by CMOC Limited in relation to the Triple Flag Streaming Agreement by Evolution;
- 100% of the shares in CMOC Mining Pty Limited (the "**CMOC Participant**"), the entity which holds an 80% Participating Interest in the Northparkes copper-gold mine in New South Wales ("**Northparkes Mine**") through an unincorporated joint venture with Sumitomo Metal Mining Oceania Pty Ltd ("**SMM**") and SC Mineral Resources Pty Ltd ("**SC**") (SMM and SC collectively, the Sumitomo Parties) (the "**Northparkes JV**"); and
- an indirect interest in the CMOC Participant's wholly owned subsidiary, CMOC Mining Services Pty Ltd ("**CMOC Mining Services**"); and
- the entry into of an associated offtake agreement with IXM S.A. (a related body corporate of CMOC Group Limited) for 100% of the copper concentrates produced from the Northparkes Mine which is attributable to the CMOC Participant's 80% Participating Interest in the Northparkes JV ("**Offtake Agreement**"),

(CMOC Metals and the CMOC Participant and CMOC Mining Services each being "Target Group Members", collectively the "Target Group");

- a fully underwritten institutional placement of new ordinary shares in Evolution ("**New Shares**") to be made to eligible institutional shareholders of Evolution under section 708A of the Corporations Act 2001 (Cth) ("**Corporations Act**"), as modified by the Australian Securities and Investments Commission ("**ASIC**") Corporations (Disregarding Technical Relief) Instrument 2016/73 ("**Placement**"); and
- a non-underwritten offer of New Shares to eligible Evolution shareholders under a share purchase plan in accordance with ASIC Corporations (Share and Interest Purchase Plans) Instrument 2019/547 ("**SPP**") (the Placement and SPP together, the "**Equity Raising**").

Information in relation to Evolution

This presentation contains summary information about Evolution and its subsidiaries and their activities which is current as at the date of this presentation. The information in this presentation is of a general background nature and does not purport to be complete or to provide all information that an investor may require when making an investment decision, nor does it contain all the information which would be required in a disclosure document or prospectus prepared in accordance with the requirements of the Corporations Act. It has been prepared by Evolution with due care but no representation or warranty, express or implied, is provided in relation to the accuracy or completeness of the information. Statements in this presentation are made only as of the date of this presentation unless otherwise stated and the information in this presentation remains subject to change without notice. Evolution is not responsible for updating, nor undertakes to update, this presentation. It should be read in conjunction with Evolution's other periodic and continuous disclosure announcements lodged with the Australian Securities Exchange ("**ASX**"), which are available at www.asx.com.au

Investors should note that while Evolution's Mineral Resource and Ore Reserve estimates comply with the JORC Code, they may not comply with the relevant guidelines in other countries.

Timetable and Equity Raising

Evolution reserves the right to withdraw the Equity Raising or vary the timetable for the Equity Raising without notice.

Limitation on information in relation to the Northparkes Mine

All information in this presentation in relation to Northparkes Mine - including in relation to production, resources and reserves, costs, financial information and life of mine plans of the Northparkes Mine has been sourced from materials provided by CMOC Group Limited ("**CMOC**") and its affiliates. Neither Evolution nor CMOC have independently verified such information and no representation or warranty, expressed or implied, is made as to its fairness, accuracy, correctness, completeness or adequacy. CMOC has not prepared this presentation and has not authorised its release. CMOC expressly disclaims any liability in connection with this presentation, and any statement contained in it. Investors should treat any information relating to the Northparkes Mine with caution.

Reserves and resources reporting of Evolution and the Northparkes Mine

Investors should note that it is a requirement of the ASX listing rules that the reporting of Ore Reserves and Mineral Resources in Australia comply with the Australasian Joint Ore Reserves Committee Code for Reporting of Mineral Resources and Ore Reserves (the "**JORC Code**"), whereas mining companies in other countries may be required to report their Ore Reserves and/or Mineral Resources in accordance with other guidelines (for example, SEC Industry Guide 7 in the United States). In particular, they do not comply with Item 1300 of Regulation S-K, which governs disclosures of Ore Reserves in registration statements filed with the United States Securities and Exchange Commission. Information contained in this document describing mineral deposits may not be comparable to similar information made public by companies subject to the reporting and disclosure requirements of Canadian or US securities laws. You should not assume that quantities reported as "resources" will be converted to reserves under the JORC Code or any other reporting regime or that Company will be able to legally and economically extract them.

Investors should also note that the reporting of resource and reserve estimates for the Northparkes Mine ("**CMOC's Estimates**") are not reported in accordance with the JORC Code 2012. A Competent Person has not done sufficient work to classify CMOC's Estimates as Mineral Resources and Ore Reserves in accordance with the JORC Code. It is possible that following evaluation and/or further exploration work CMOC's Estimates may materially change and hence will need to be reported afresh under and in accordance with the JORC Code. Nothing has come to Evolution's attention that causes it to question the accuracy or reliability of CMOC's Estimates, but Evolution has not independently validated CMOC's Estimates and therefore is not to be regarded as reporting, adopting or endorsing those estimates. For more information as to CMOC's Estimate, please refer to Evolution's ASX announcement accompanying this investor presentation

IMPORTANT NOTICES (2/3)

Not financial product advice

This presentation is not a financial product or investment advice, a recommendation to acquire New Shares or accounting, legal or tax advice and does not and will not form any part of any contract for the acquisition of New Shares. It has been prepared without taking into account the objectives, financial or tax situation or needs of individuals. Before making an investment decision, prospective investors should consider the appropriateness of the information having regard to their own objectives, financial and tax situation and needs and seek legal and taxation advice appropriate for their jurisdiction. Evolution is not licensed to provide financial product advice in respect of an investment in shares. Cooling off rights do not apply to the acquisition of New Shares.

Effect of rounding

A number of figures, amounts, percentages, estimates, calculations of value and fractions in this presentation are subject to the effect of rounding. Accordingly, the actual calculation of these figures may differ from the figures set out in this presentation

Financial Data

All dollar values are in Australian dollars (“\$” or “A\$”) unless stated otherwise. The financial information for Evolution included in this presentation has been prepared in accordance with Australian Accounting Standards (“AAS”), which complies with International Financial Reporting Standards (“IFRS”). The pro forma financial information included in this presentation is for illustrative purposes and does not purport to be in compliance with Article 11 of Regulation S-X of the rules and regulations of the U.S. Securities and Exchange Commission. Investors should be aware that financial data in this presentation include “non-IFRS financial information” under ASIC Regulatory Guide 230 Disclosing non-IFRS financial information published by ASIC and also “non-GAAP financial measures” within the meaning of Regulation G under the U.S. Securities Exchange Act of 1934. Non-IFRS/non-GAAP measures in this presentation include gearing, sustaining capital, major product capital, major mine development, production cost information such as All-in Sustaining Cost and All-in Cost. Evolution believes this non-IFRS/non-GAAP financial information provides useful information to users in measuring the financial performance and conditions of Evolution. The non-IFRS financial information do not have a standardised meaning prescribed by AAS and, therefore, may not be comparable to similarly titled measures presented by other entities, nor should they be construed as an alternative to other financial measures determined in accordance with AAS. Investors are cautioned, therefore, not to place undue reliance on any non-IFRS/non-GAAP financial information and ratios included in this presentation. Financial data for the Northparkes Mine contained in this presentation has been derived from financial statements and other financial information made available by CMOC in connection with the proposed Transaction. Such financial information is unaudited.

Past performance

Past performance and pro-forma financial information given in this presentation is given for illustrative purposes only and should not be relied upon as (and is not) an indication of Evolution’s views on its future financial performance or condition. Investors should note that past performance of Evolution, including the historical trading price of the shares, cannot be relied upon as an indicator of (and provides no guidance as to) future Evolution performance, including the future trading price of shares. The historical information included in this presentation is, or is based on, information that has previously been released to the market. For further information, please see past announcements released to the ASX.

Future performance

This presentation contains forward looking statements about Evolution and the Northparkes Mine. Often, but not always, forward looking statements can generally be identified by the use of forward looking words such as “may”, “will”, “expect”, “intend”, “plan”, “estimate”, “anticipate”, “continue”, and “guidance”, or other similar words and may include, without limitation, statements regarding plans, strategies and objectives of management, product target and forecast financials, anticipated construction/expansion commencement dates, expected costs or production outputs for each of Evolution and the Northparkes Mine, the outcome and effects of the proposed Transaction and the future operation of Evolution and the Northparkes Mine. To the extent that these materials contain forward looking information, the forward looking information is subject to a number of risk factors. Any such forward looking statement also inherently involves known and unknown risks, uncertainties and other factors that may cause actual results, performance and achievements to be materially greater or less than estimated (refer to the key risks appendix of this presentation).

These factors may include, but are not limited to, risks and uncertainties associated with the impacts of pandemics (such as COVID-19), the hostility between Russia and Ukraine, the hostility in Israel and the Gaza territory, changes in commodity prices, foreign exchange fluctuations and general economic conditions, increased costs and demand for production inputs, the speculative nature of exploration and project development, including the risks of obtaining necessary licenses and permits and diminishing quantities or grades of reserves, political and social risks, changes to the regulatory framework within which Evolution operate or may in the future operate, environmental conditions including extreme weather conditions, recruitment and retention of personnel, industrial relations issues and litigation. Any such forward looking statements are also based on current assumptions which may ultimately prove to be materially incorrect. Investors should consider the forward looking statements contained in this presentation in light of those disclosures and not place reliance on such statements. The forward looking statements in this presentation are not guarantees or predictions of future performance. The forward looking statements are based on information available to Evolution as at the date of this presentation. Except as required by law or regulation (including the ASX Listing Rules), Evolution undertakes no obligation to provide any additional or updated information whether as a result of new information, future events or results or otherwise. Indications of, and guidance on, future earnings or financial position or performance are also forward looking statements.

Investment risk

An investment in shares in Evolution is subject to investment and other known and unknown risks, some of which are beyond the control of Evolution. Evolution does not guarantee any particular rate of return or the performance of Evolution, nor does it guarantee the repayment of capital from Evolution or any particular tax treatment. Readers should have regard to the risks outlined in the key risks appendix of this presentation.

Not an offer

This presentation is for information purposes only and is not an offer or an invitation to acquire shares or any other financial products in any place in which, or to any person to whom, it would be unlawful to make such an offer or invitation. This presentation is not a prospectus, product disclosure statement or other disclosure document under Australian law (and will not be lodged with ASIC) or any law.

The information in this presentation does not constitute an offer in any jurisdiction in which, or to any person to whom, it would not be lawful to make such an offer. This presentation does not constitute an offer to sell, or the solicitation of an offer to buy, any New Shares in the United States. The New Shares have not been, and will not be, registered under the U.S. Securities Act of 1933 (“U.S. Securities Act”) or the securities laws of any state or other jurisdiction of the United States. The New Shares may not be offered or sold, directly or indirectly, in the United States unless they have been registered under the U.S. Securities Act or are offered and sold in a transaction exempt from, or not subject to, the registration requirements of the U.S. Securities Act and any other applicable U.S. state securities laws. The distribution of this presentation (including an electronic copy) outside Australia and New Zealand may be restricted by law. If you come into possession of this presentation, you should observe such restrictions and should seek your own advice on such restrictions. Any non-compliance with these restrictions may contravene applicable securities laws. Refer to the International Offering Restrictions appendix of this presentation for more information. By accepting this presentation you represent and warrant that you are entitled to receive such presentation in accordance with the above restrictions and agree to be bound by the limitations contained herein.

IMPORTANT NOTICES (3/3)

Underwriter

The underwriter ("**Underwriter**") has acted as lead manager and underwriter to the Placement. The SPP is not underwritten. Neither the underwriter nor its Extended Parties (defined below) have authorised, permitted or caused the issue, lodgement, submission, dispatch or provision of this presentation, make or purport to make any statement in this presentation and there is no statement in this presentation which is based on any statement by any of them. The underwriter and its Extended Parties do not make any recommendation as to whether any potential investor should participate in the Equity Raising.

Disclaimer

For the avoidance of any doubt, the Underwriter and each of their respective affiliates, related bodies corporate, and each of their respective advisors, directors, officers, partners, employees, agents and associates ("**Extended Parties**") have not made or purported to make any statement in his presentation and there is no statement in this presentation which is based on any statement by any of them.

Accordingly, given the presentation is Evolution's document, to the maximum extent permitted by law, the Underwriter and its Extended Parties:

- take no responsibility in respect of, and make no representations or warranties (express or implied) as to the fairness, currency, accuracy, reasonableness, reliability or completeness of, the information in this presentation;
- exclude and disclaim any duty or liability (including, without limitation, any liability arising from fault, negligence or negligent misstatement) as a result of your participation in the Equity Raising and the information in this presentation being inaccurate or incomplete in any way for any reason, whether by negligence or otherwise.

Neither the Underwriter nor any of its Extended Parties guarantees the repayment of capital or any particular rate of income or capital return on an investment in Evolution. Statements in this presentation are made only as at the date of this presentation. The information in this presentation remains subject to change without notice.

Neither Evolution, the Underwriter nor any of their respective Extended Parties accept any fiduciary obligations to or any relationship with any investor or potential investor in connection with the Equity Raising or otherwise. Determination of eligibility of investors for the purposes of the Equity Raising is determined by reference to a number of matters, including legal requirements and the discretion of Evolution and the Underwriter. To the maximum extent permitted by law, the Underwriter disclaims any duty or liability in respect of the exercise or otherwise of that discretion.

To the maximum extent permitted by law, you agree to release and indemnify the Underwriter and its Extended Parties from and against all claims, actions, damages, remedies or other matters, whether in tort, contract or under law or otherwise, arising from or which may arise from or in connection with the provision of, or any purported reliance on, this presentation and you covenant that no claim or allegations will be made against the Underwriter or its Extended Parties in relation to this presentation.

Disclosure

The underwriter, together with its affiliates, is a full service financial institution and commercial bank engaged in various activities, which may include trading, financing, financial advisory, investment management, investment banking, investment research, principal investment, hedging, market making, margin lending, brokerage, financing and financial advisory services and other financial and non financial activities and services including for which they have received or may receive customary fees and expenses. The underwriter and/or its affiliates have performed, and may perform, other financial or advisory services for Evolution, and/ or may have other interests in or relationships with Evolution, and its related entities for which they have received or may receive customary fees and expenses or other transaction consideration.

In the ordinary course of these various business activities, the underwriter and its affiliates may at any time purchase, sell or hold a broad array of investments and actively trade or effect transactions in equity, debt and other securities, derivatives, loans, commodities, currencies, credit default swaps and/or other financial instruments for their own account and for the accounts of their clients make or hold investments in equity, and such investment and trading activities may involve or relate to assets, securities and/ or other financial products of Evolution, its related entities and/or persons and entities with relationships with Evolution and/or its related entities, and may receive customary fees and expenses or other transaction consideration in respect of such activities. The underwriter and/or its affiliates, or their respective officers, employees, consultants or agents may, from time to time, have long or short positions in, buy or sell (on a principal basis or otherwise), and may act as market makers in, the securities or derivatives, or serve as a director of any entities mentioned herein.

The underwriter is acting for and providing services to Evolution in relation to the Placement and will not be acting for or providing services to Evolution shareholders or creditors. The underwriter has been engaged solely as an independent contractor and is acting solely in a contractual relationship on an arm's length basis with Evolution. The engagement of the underwriter by Evolution is not intended to create any agency or other relationship between the underwriter and Evolution's shareholders or creditors.

The underwriter, in conjunction with its affiliates, is acting in the capacity as such in relation to the Placement and will receive fees and expenses for acting in this capacity.

In connection with the Placement, one or more institutional investors may elect to acquire an economic interest in the New Shares ("**Economic Interest**"), instead of subscribing for or acquiring the legal or beneficial interest in those securities. The underwriter or its affiliates may, for its own account, write derivative transactions with these investors relating to the New Shares to provide the Economic Interest or otherwise acquire New Shares in Evolution in connection with the writing of those derivative transactions in the Placement and/or the secondary market. As a result of those transactions, the underwriter (or its affiliates) may be allocated, subscribe for or acquire New Shares or securities of Evolution in the Placement and/or the secondary market, and may continue to hold long or short positions in, equity, debt and/or related derivative securities of Evolution and/or its related entities. These transactions may, together with other securities in Evolution acquired by the underwriter or its affiliates in connection with their ordinary course sales and trading, principal investing and other activities, result in the underwriter or its affiliates disclosing a substantial holding and earning fees.

None of the Extended Parties make any recommendations as to whether you or your related parties should participate in the Equity Raising nor do they make any representations or warranties (expressed or implied) to you (or other statements upon which you may rely) concerning the Equity Raising or any such information. The engagement of the underwriter by Evolution is not intended to and does not create any agency, custodial, fiduciary or other legal relationship between the underwriter and any shareholder or other investor.

Acceptance

By attending an investor presentation or briefing, or accepting, accessing or reviewing this presentation you acknowledge and agree to the terms set out in the important notes and disclaimer.

TABLE OF CONTENTS

- 1 Northparkes opportunity
- 2 Transaction summary
- 3 Northparkes overview and highlights
- 4 Transaction funding
- 5 Appendices



01

NORTHPARKES OPPORTUNITY



ACQUISITION OF NORTH PARKES (80%)

Established, long-life copper-gold asset with significant upside potential

On strategy

Creating a portfolio of long-life gold & copper assets

Immediate cash generating asset

Strong YTD¹ CY2023 cash flows

Well-established, long-life operation

FY24E production of 25kt Cu, 38koz Au^{2,3}

In an attractive mining region

Highly prospective geology and close to Cowal

Financially accretive transaction

Accretive to Evolution across a variety of metrics

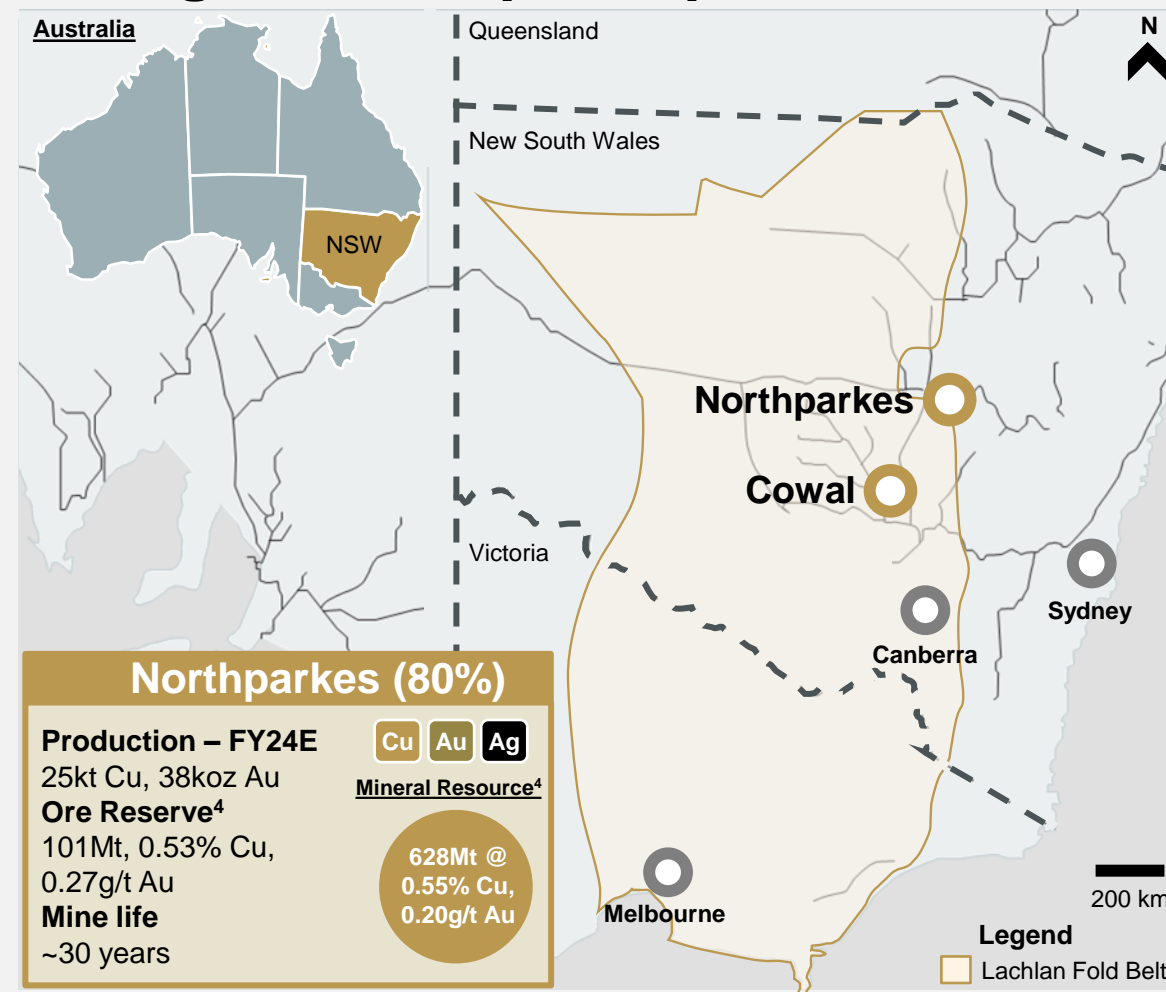

1. Based on Northparkes' production and financial performance for CY2023 YTD October (inclusive)
2. Production shown on a full year basis to 30 June 2024 at the 80% interest level of Evolution. Evolution only entitled to production post transaction close. Based on Evolution's due diligence and information provided by CMOC
3. Northparkes FY24E forecast production is shown on an 80% attributed basis to Evolution
4. Evolution reports Northparkes Mineral Resource and Ore Reserve (as reported by CMOC) on a 100% basis but is attributed 80%. Investors should note that the reporting of Mineral Resource and Ore Reserve estimates for the Northparkes Mine ("CMOC's estimates") are not reported in accordance with the JORC Code 2012. Full details are provided in the ASX announcement accompanying this investor presentation

ACQUISITION ALIGNS WITH STRATEGY

Delivering long-term stakeholder value with a business that prospers through the cycle

Clear and consistent strategy



Create sustainable value for stakeholders in an environmentally and socially responsible way



High performing culture with values and reputation as non-negotiables



Willing to take appropriate geological, operational and financial risks



A portfolio of up to 8 assets in Tier 1 jurisdictions generating superior returns



Financial discipline centred around margin and appropriate capital returns

Transaction fit



Proven strong social licence and community support



Highly independent site team, strong technical skill base



Long history of Ore Reserve replenishment and mine life extension



Increases Evolution's exposure to copper to ~30% of revenue on a FY24E basis¹



Well capitalised operation with lower capital intensity in next few years

IN OUR SWEET SPOT



Compelling opportunity – vendor redeploying capital in other geographies



Supportive, high-quality partners in Sumitomo Group and Triple Flag



Long mine life ~30 years with geological upside in our backyard



Improves portfolio quality and delivers an accretive outcome for shareholders





02

TRANSACTION SUMMARY

TRANSACTION SUMMARY

<p>Transaction details</p>	<ul style="list-style-type: none"> ▪ Evolution Mining (“Evolution” or the “Company”) has entered into a binding agreement to acquire an 80% interest in the Northparkes Copper-Gold Mine (“Northparkes” or “Northparkes JV”) from CMOC Group Limited (“CMOC”) (the “Transaction”), for total cash consideration of up to US\$475m, comprised of: <ul style="list-style-type: none"> – an upfront cash consideration of US\$400m; and – contingent consideration of up to US\$75m (“Contingent Consideration”)¹ ▪ Sumitomo Metal Mining and Sumitomo Corporation (and its affiliates) (together “Sumitomo Group” or “Sumitomo”) will retain their 20% interest in the Northparkes JV ▪ Under the Transaction structure, Evolution will acquire all the shares in CMOC’s Australian subsidiary CMOC Mining Pty Ltd, which will not trigger any pre-emptive rights² ▪ Evolution will assume the obligations of CMOC Limited as guarantor under the Triple Flag Metal Purchase and Sale Agreement (“Triple Flag Stream”) (slide 15 for additional information) ▪ Evolution has also agreed to enter into an offtake agreement (on market equivalent terms) with IXM S.A. (“IXM”) (a subsidiary of CMOC) under which IXM will purchase from Evolution copper concentrates produced from the Northparkes mine equal to Evolution’s 80% attributable interest over the life of mine’s existing Ore Reserves
<p>Due diligence and JORC reporting</p>	<ul style="list-style-type: none"> ▪ Information provided in relation to the Northparkes Resource and Reserve estimate was reported by CMOC in a report titled “Annual Results Announcement for the Year Ended 31 December 2022” filed with the Hong Kong Stock Exchange dated 17 March 2023 ▪ Whilst Evolution has undertaken extensive diligence on the Northparkes Resources and Reserves estimate, it is possible that these estimates may change following evaluation and / or further exploration work, requiring an updated estimate to be reported under and in accordance with the JORC Code 2012 ▪ Nothing has come to Evolution’s attention that causes it to question the accuracy or reliability of CMOC’s estimates; however, Evolution has not independently validated CMOC’s estimates and therefore is not to be regarded as reporting, adopting or endorsing those estimates ▪ Evolution intends to release a JORC Code 2012 compliant Mineral Resources and Ore Reserves statement for Northparkes during Q3 FY24
<p>Valuation and key metrics</p>	<ul style="list-style-type: none"> ▪ Based on an acquisition Enterprise Value (“EV”) of US\$756m³ implies: <ul style="list-style-type: none"> – an EV / FY23 EBITDA multiple of 7.0x⁴; and an EV / Reserve multiple of US\$0.58/lb CuEq⁵; and an EV / Resource multiple of US\$0.10/lb CuEq⁶ ▪ The transaction is accretive to Evolution across a variety of key per share metrics, notably: <ul style="list-style-type: none"> – Gold-equivalent production (+5%) for FY24E⁷; and Resources (AuEq) (+32%)⁸; and Reserves (AuEq) (+9%)⁹ ▪ Pro-forma gearing post-Placement of ~34%¹⁰ and current dividend policy unchanged

TRANSACTION SUMMARY CONT

Transaction funding	<ul style="list-style-type: none"> ▪ The upfront cash consideration is to be funded via a combination of a new A\$200m Term Debt Facility and a fully underwritten¹¹ A\$525m institutional placement (“Placement”) ▪ In addition to the Placement, Evolution announces a non-underwritten share purchase plan for Evolution’s eligible retail shareholders (“SPP”) to raise up to A\$60m¹² (together with the Placement, the “Equity Raising”)
Timing and conditions	<ul style="list-style-type: none"> ▪ Transaction completion expected to occur before the end of December 2023 and is not subject to any conditions precedent

1. The copper price-linked Contingent Consideration is based on the following key terms:
 - a) 3-year term, commencing 1 July 2024 and ending 30 June 2027 (inclusive).
 - b) Payments made annually to CMOC based on three incremental pricing thresholds:
 - I. Threshold 1: 25% of incremental revenue share per pound of payable copper at prices at or above US\$4.00/lb but less than US\$4.25/lb; plus
 - II. Threshold 1: 35% of incremental revenue share per pound of payable copper at prices at or above US\$4.25/lb but less than US\$4.50/lb; plus
 - III. Threshold 3: 45% of incremental revenue share per pound of payable copper at prices at or above US\$4.50/lb.
 - c) Contingent cash Consideration to be capped at US\$75m.
2. The Northparkes Joint Venture is subject to pre-emptive rights. However, the Transaction itself is not subject to pre-emptive rights
3. Acquisition Enterprise Value inclusive of the Fair Value of the Triple Flag stream liability of US\$356m which is based on the outstanding commitment of ounces at the long-term gold price of A\$2,650/oz
4. Derived from Acquisition Enterprise Value as defined in footnote 3 and an FY23 EBITDA of US\$107m
5. Derived from Acquisition Enterprise Value as defined in footnote 3 and Northparkes’ Ore Reserve estimates as at 31 December 2022 converted to copper-equivalent using commodity price assumptions of A\$1,600/oz Au, A\$20/oz Ag and A\$7,000/t Cu
6. Derived from Acquisition Enterprise Value as defined in footnote 3 and Northparkes’ Mineral Resource estimates as at 31 December 2022 converted to copper-equivalent using commodity price assumptions of A\$2,200/oz Au, A\$26/oz Ag and A\$10,000/t Cu
7. Based on the gold-equivalent ounce per share of Evolution’s standalone Production and Evolution’s pro-forma production (including Northparkes’ Production) using commodity price assumptions based on spot prices as at 30 November 2023 of US\$3.82/lb copper, US\$2,044/oz gold
8. Based on the gold-equivalent ounce per share of Evolution’s standalone Mineral Resource and Evolution’s pro-forma (including Northparkes) Mineral Resource using commodity price assumptions of A\$2,200/oz Au, A\$26/oz Ag and A\$10,000/t Cu for Mineral Resources
9. Based on the gold-equivalent ounce per share of Evolution’s standalone Ore Reserve and Evolution’s pro-forma Ore Reserve (including Northparkes’ Ore Reserve) using commodity price assumptions of A\$1,600/oz Au, A\$20/oz Ag and A\$7,000/t Cu for Ore Reserves
10. Calculated as Net Debt divided by (Net Debt + Book Value of Equity) of Evolution’s pro-forma balance sheet estimates post-acquisition
11. Refer to the summary of the underwriting agreement appendix of this presentation
12. In conjunction with the placement, Evolution is undertaking a non-underwritten SPP, to raise up to A\$60m, although Evolution may decide to accept applications that result in the SPP raising more or less than this amount

NORTHPARKES ACQUISITION SNAPSHOT

Immediate cash flow supports deleveraging

~A\$120m
cash flow YTD CY23¹

Attractive exposure to copper

FY24E 25kt of Cu
to Evolution²

Ore Reserve growth upside

5x
The current ratio of Mineral Resource to Ore Reserve³

Consistent with our long-asset life strategy

~30 year
mine life

Near term, low capital intensity options available

Mining method optionality

Large scale underground mining experience

At Ernest Henry
copper and gold mine

Large Mineral Resource in our backyard

8 years
Operated Cowal since 2015

Commitment to growth in regional NSW

2x long-life
operations in central west NSW

A compelling acquisition improving our portfolio



1. Based on operating cash flows less investing cash flows as provided by CMOC for CY2023 October YTD (inclusive). Note this is unadjusted for streaming payments under the Triple Flag Stream
2. Full year Northparkes FY24E forecast production is shown on an 80% attributed basis to Evolution
3. 5x represents the ratio of Mineral Resource (exclusive of Ore Reserve) to Ore Reserve on a total tonnage basis. Evolution reports Northparkes Mineral Resource and Ore Reserve on a 100% basis but is attributed 80%

FY24E EVOLUTION POST-ACQUISITION¹

FY24E Evolution Guidance (see slide 31)	Gold (oz) (+/-5%)	Copper (t) (+/-5%)	AISC (A\$/oz) (+/-5%)	Sustaining Capital (A\$m)	Major Project Capital (A\$m)	Major Mine Development (A\$m)
Group	789,000	62,500	1,340	200 – 245	335 – 365	135 – 155
Northparkes² (6 months to June 2024)	19,000	12,500	150	10 – 15	10 – 15	10 – 15

Evolution's production guidance

Production forecast (Au koz)²

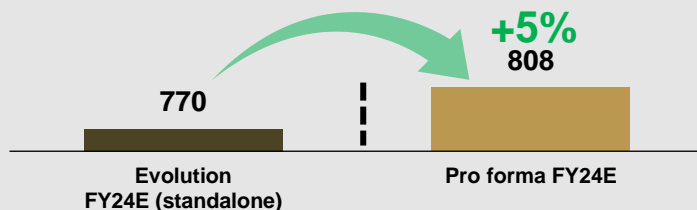

Production forecast (Cu kt)²

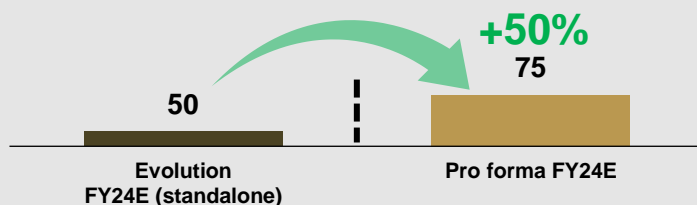

Reduces Group capital intensity

Capital expenditure forecast (A\$/AuEq oz)^{2,3,4}

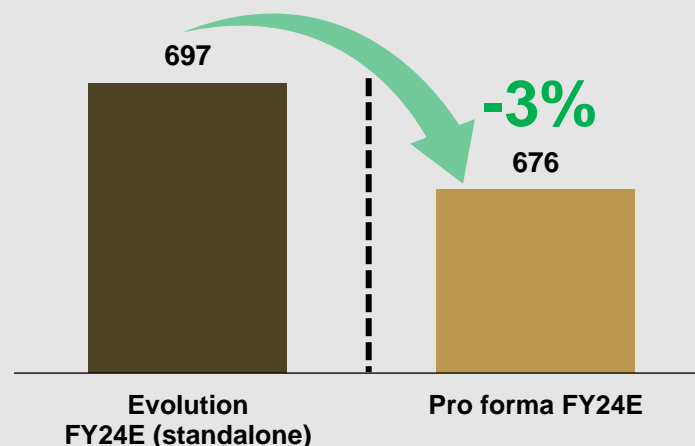

Consistent with our strategy of a low-cost portfolio

Group AISC forecast (A\$/oz)^{2,5}

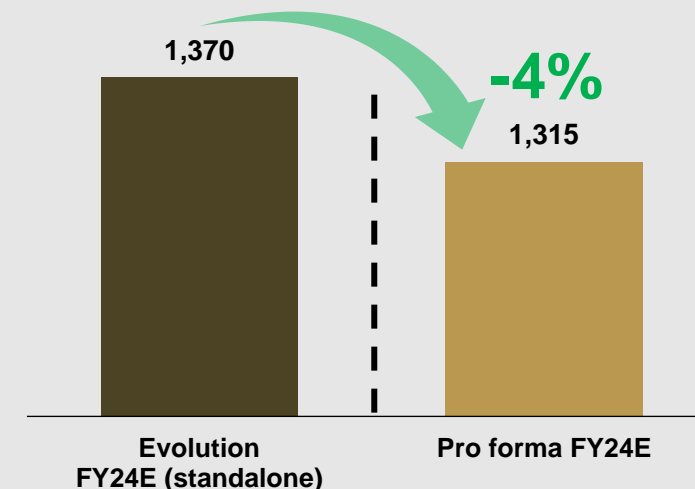

- Figures for Evolution represent Evolution's forecast FY24E production, capital expenditure and AISC. These forecasts are subject to a variety of risks, including unforeseen production interruptions, lower than expected grades and changes in input costs. Production, capital expenditure and AISC estimates including Northparkes have been provided for illustrative purposes only to indicate what Evolution's forecast FY24E production would have been if it had owned 80% of Northparkes for the periods indicated
- Northparkes' FY24E forecast is based on Evolution's due diligence and information provided by CMOC
- Evolution's FY24E Guidance and full year Northparkes FY24E forecast production is converted to AuEq (in koz) based on the following spot prices as at 30 November 2023 of US\$3.82/lb copper, US\$2,044/oz gold. AuEq (koz) = (Au koz) + [(Copper Price multiplied by copper production divided by Gold Price)]
- Capital intensity is reported on a per AuEq oz basis based on production figures shown on the left. Evolution's FY24E guidance capital expenditure of A\$680m (mid-point of guidance taken: A\$210m sustaining capital, A\$338m major capital, and A\$133m major mine development). Northparkes FY24E forecast capital expenditure of A\$75m (mid-point of guidance taken and doubled for a full year: A\$12.5m sustaining capital, A\$12.5m major capital, and A\$12.5m major mine development). Combined FY24E AISC forecast is calculated based on the weighted average of Evolution's FY24E Au production and reported AISC cost of A\$1,370/oz and Northparkes FY24E Au production and AISC of A\$150/oz

STRUCTURE AND STREAM OVERVIEW

Triple Flag Stream

Key terms	<ul style="list-style-type: none"> CMOC entered into a Stream agreement in 2020 with Triple Flag Triple Flag to make ongoing payments equal to 10% of spot metal price delivered Evolution will assume CMOC's obligations under the Triple Flag Stream Agreement as part of the Transaction
Stream	<p>Stage 1 – up to 630koz (38koz of Au delivered to date^{1,2})</p> <ul style="list-style-type: none"> 67.5% of gold and 100% of silver production attributable to Evolution <p>Stage 2 – LOM post Stage 1</p> <ul style="list-style-type: none"> 33.75% of gold and 50% of silver production attributable to Evolution

Evolution reporting

- Stream liability will be fair valued on the balance sheet³ as part of acquisition based on outstanding commitment of ounces at a long term gold price A\$2,650/oz
- Evolution share of Northparkes' production, sales and costs to be reported per other assets
- Gold sales will comprise 39% at spot price and 61% at the fair value price⁵
- Stream liability will be amortised to the P&L (based on the production/sales ounces), with a corresponding tax depreciation claimed for the market value of 80% of the mine acquired

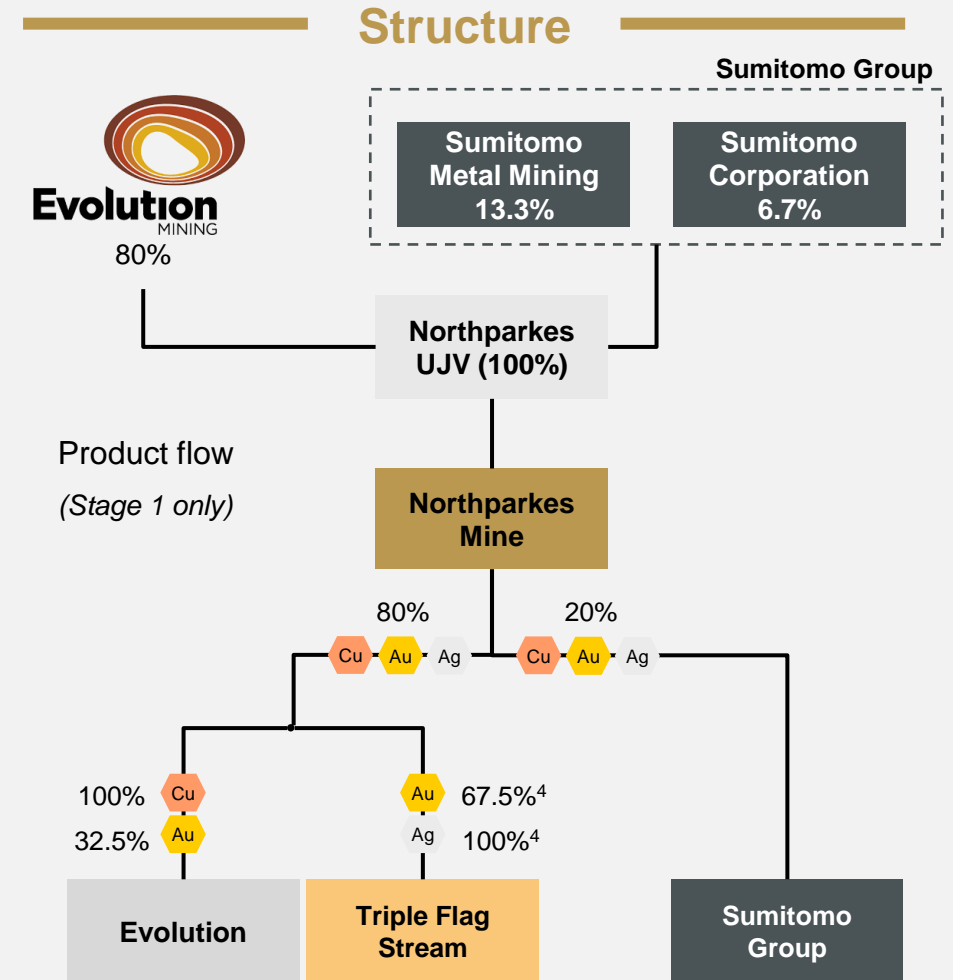

- CMOC delivery based on Triple Flag's September 2023 quarterly report, since inception of the stream in July 2020 to 30 September 2023
- Represents 6% of the "Stage 1" cap of 630koz Au, before the step down in the stream percentage from 67.5% of CMOC's share of payable gold production to 32.5%
- Tax depreciation for the market value of the 80% of the mine acquired
- Represented "Stage 1" of the stream only
- 61% fair value reflects 67.5% of gold sold at 10% of the spot price, with the remainder (39%) unincumbered



03

NORTHPARKES OVERVIEW AND HIGHLIGHTS

OVERVIEW OF NORTHPARKES

Asset overview¹

Commodities	<ul style="list-style-type: none"> ▪ Copper, Gold, Silver
Evolution ownership	<ul style="list-style-type: none"> ▪ 80%
Mine Life	<ul style="list-style-type: none"> ▪ ~30 years
Operator	<ul style="list-style-type: none"> ▪ Evolution
Location	<ul style="list-style-type: none"> ▪ New South Wales, Australia
Mine type & mining method	<ul style="list-style-type: none"> ▪ Block caving + Sub-level caving + Open pit
Mill throughput	<ul style="list-style-type: none"> ▪ Permitted to 8.5Mtpa with current mill capacity of 7.6Mtpa ▪ ~6.5Mtpa from underground operations supplemented periodically by open cut and/or stockpiles
Processing method	<ul style="list-style-type: none"> ▪ Grinding & flotation plant
Recovery (YTD)²	<ul style="list-style-type: none"> ▪ 83% Cu ▪ 71% Au
Product	<ul style="list-style-type: none"> ▪ Copper-gold-silver concentrate
Production³ (FY24E full year, 80% basis)	<ul style="list-style-type: none"> ▪ 25kt Cu, 38koz Au
Mineral Resource⁴ (Reported on a 100% basis)	<ul style="list-style-type: none"> ▪ 628Mt @ 0.55% Cu and 0.20g/t Au ▪ Contained 3,435kt Cu and 4,099koz Au
Ore Reserves⁴ (Reported on a 100% basis)	<ul style="list-style-type: none"> ▪ 101Mt @ 0.53% Cu and 0.27g/t Au ▪ Contained 537kt Cu and 880koz Au

Northparkes site layout

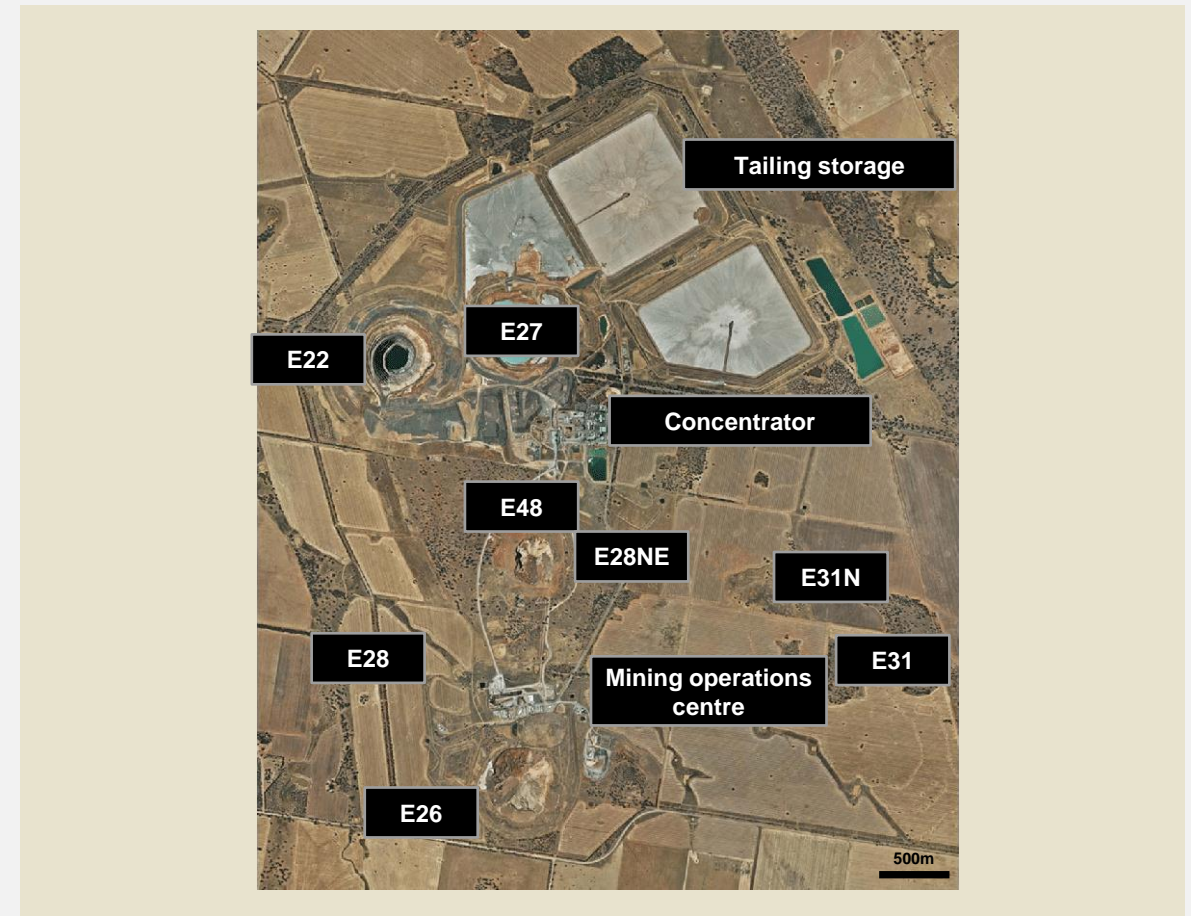

1. See also "Limitation on information in relation to the Northparkes Mine" in Important Notices

2. Based on Evolution's due diligence and information provided by CMOC. YTD recoveries for the period from January ending October 2023

3. Forecast production shown on a full year basis to 30 June 2024 at the 80% interest level of Evolution. Evolution only entitled to production post transaction close. Based on Evolution's due diligence and information provided by CMOC

4. Evolution reports Northparkes Mineral Resource and Ore Reserve on a 100% basis but is attributed 80%. Full details are provided in the ASX announcement accompanying this investor presentation

NORTHPARKES HIGHLIGHTS

1

Multiple large-scale porphyry copper and gold deposits

Suitable for bulk cave mining operation in an area well known to Evolution

2

Significant Mineral Resource base

Potential to increase mine life through conversion to Ore Reserves

3

Cash flow generation mode after significant investment

Capital for process plant expansion to 7.6Mtpa and for E26 development complete

NORTHPARKES HIGHLIGHTS (1/3)

Positioned in a well-endowed mining region in NSW

Experienced in the mining region

- Positioned in one of Australia's most prospective Gold / Copper belts (Lachlan Fold Belt)
- Concentrated mining options with five deposits within 2km radius, close to well capitalised infrastructure
- Well understood regional geology – since acquiring Cowal (2015) Ore Reserves increased 340%¹
- Extensive tenement position contiguous with mining leases, in many cases exploration drilling to depth <100m

Potential for further discoveries

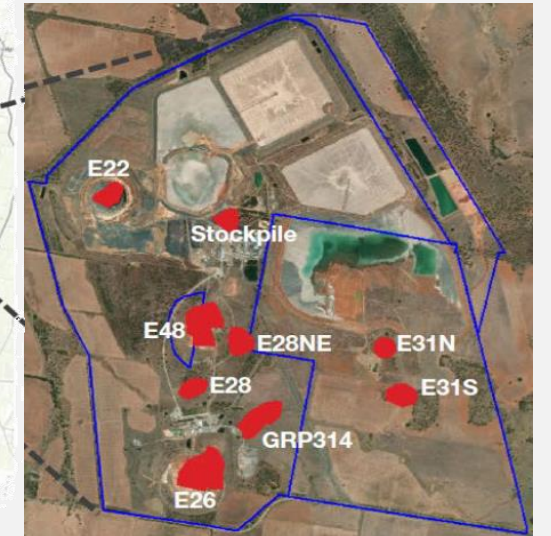
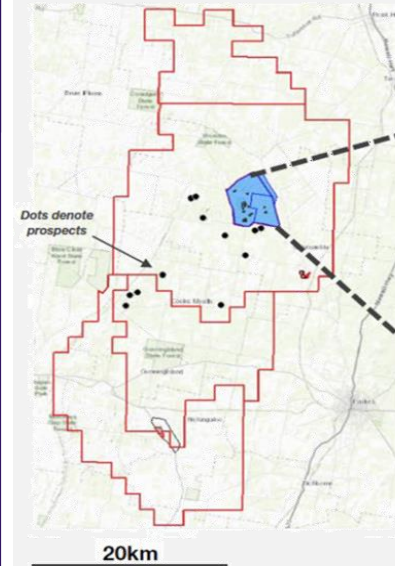
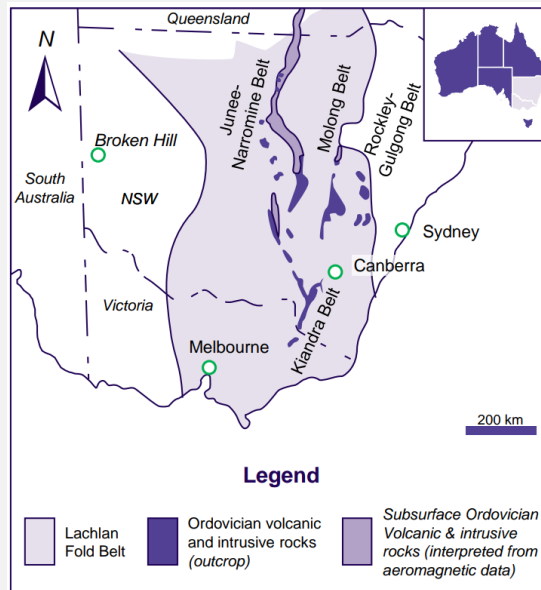

Favourable Regional Geology

Northparkes has lease entitlements covering over 1,100km²

NORTHPARKES HIGHLIGHTS (2/3)

A long-life asset with a low capital intensity option for growth

A world-class multi-decade asset

- Mine-life ~30 years. Majority of current production sourced from E26 block cave – capital development completed, additional production from E26 SLC, open cut and stockpiles
- Options available for E22 – the next production centre – include sublevel and block caving, while preserving future extensions and lower capital intensity
- A sublevel cave option for E22 would likely lower medium term capital intensity, while retaining value and near-term cashflow
- Long-term mining plans include a range of sublevel and block cave, and open cut

Development optionality for growth

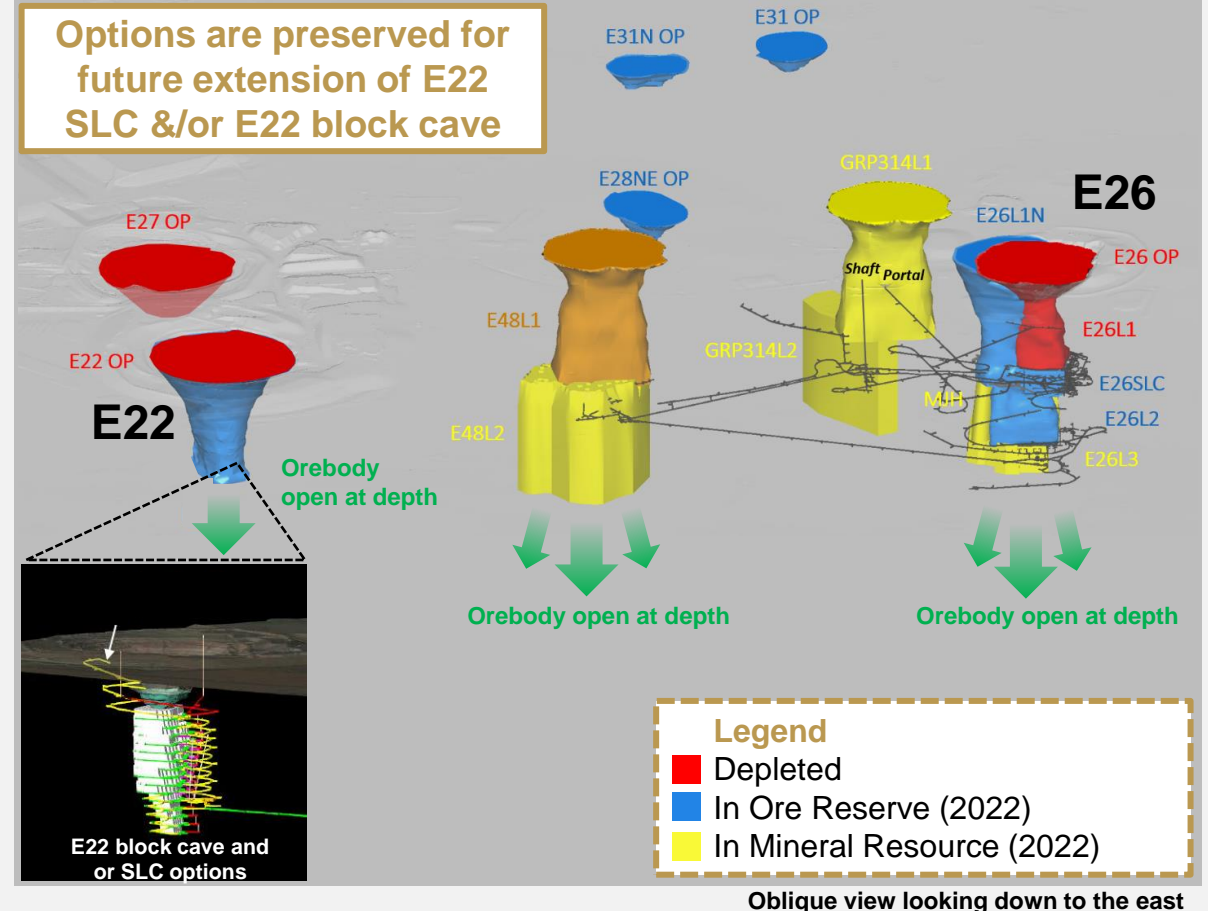

NORTHPARKES HIGHLIGHTS (3/3)

Significant Mineral Resource base with potential to grow Ore Reserves

Significant Mineral Resource conversion opportunity

- Potential for expansion and life extension opportunities is supported by a large well-defined Mineral Resource
- History of Ore Reserve growth after depletion – 49% increase since 1994¹
- ~433Mt of Mineral Resource is outside of current planned mining areas
- Resource development programs to optimise the most economic areas to inform the future mining sequence

We are growing our future with strategic investments

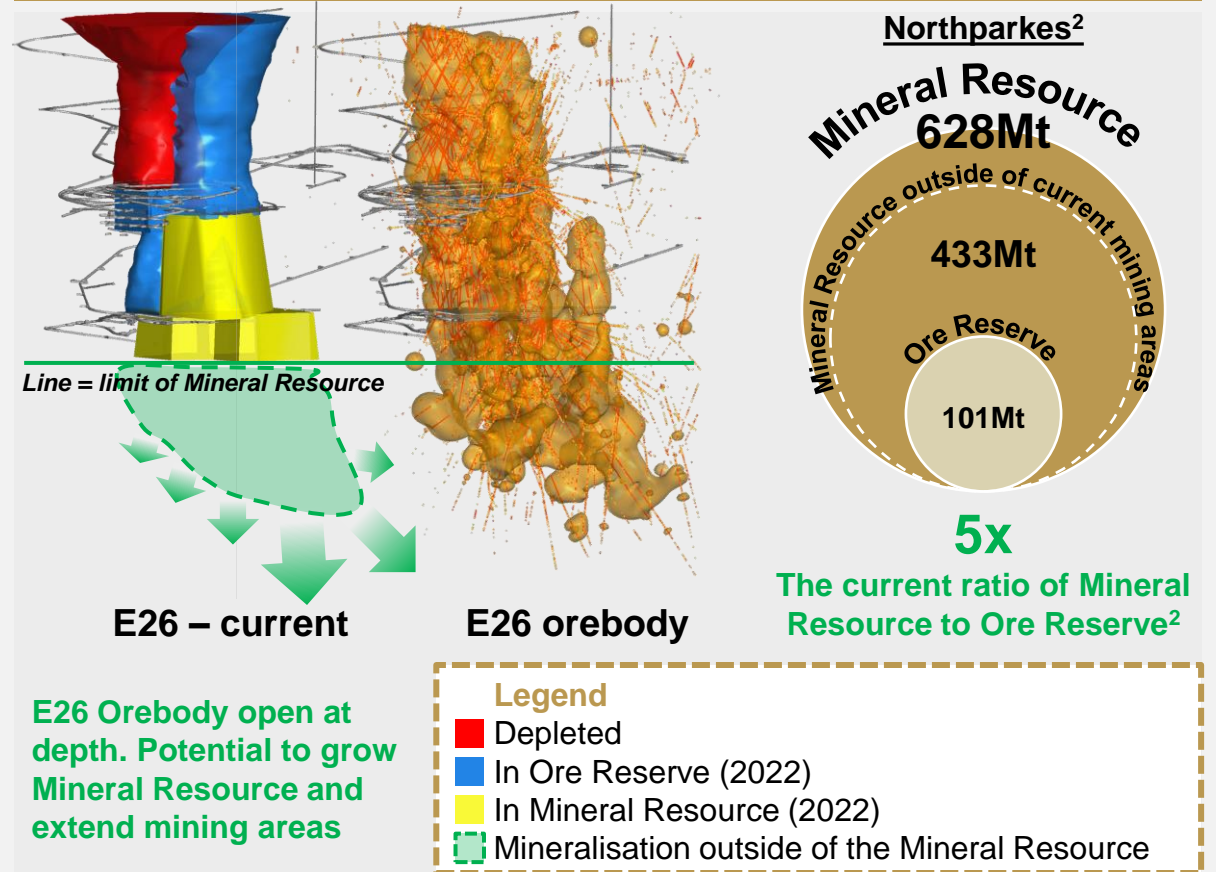

1. Since commencing production in 1994, Northparkes has grown Ore Reserve from 68Mt to 101Mt in 25 years to 2022

2. 5x represent the ratio of Mineral Resource (exclusive of Ore Reserve) to Ore Reserve on a total tonnage basis. Evolution reports Northparkes Mineral Resource and Ore Reserve on a 100% basis but is attributed 80%. Bubble size to relative scale



04

TRANSACTION FUNDING

TRANSACTION FUNDING OVERVIEW



Transaction funding¹ comprised of A\$525m placement and A\$200m new debt



Funding mix reflects Evolution's commitment to balance sheet management



Dividend policy unchanged



No corporate debt repayment until Q3 FY25

1. In conjunction with the placement, Evolution is undertaking a non-underwritten SPP, to raise up to A\$60m, although Evolution may decide to accept applications that result in the SPP raising more or less than this amount



DEBT OVERVIEW

Acquisition supported by a new A\$200m debt facility

Debt overview

- Long term debt maturity aligned with mine life
 - Average debt tenor of 6.8 years with 74% long-term debt
- Pro forma gearing of 34% (pre SPP funding)
- Group funding cost post transaction of ~5.0%
- Cash generation from Northparkes and funding mix aligns with our deleveraging plan

New A\$200m debt facility

- Term loan with 5 year tenor
- Cost in line with existing Facility F
- No debt repayment until January 2025

Debt maturity profile (A\$m)

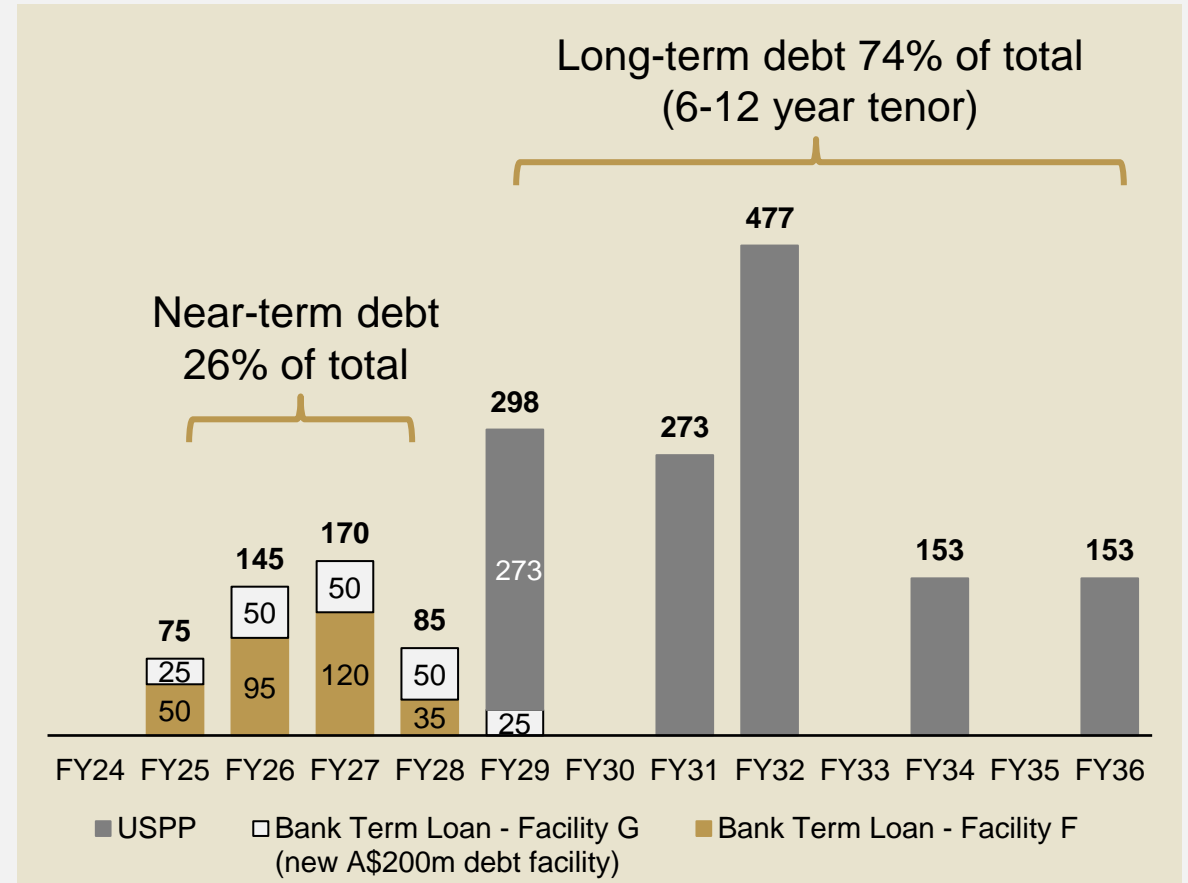

EQUITY RAISING DETAILS

Equity raising comprising A\$525m placement and SPP

Offer size and structure	<ul style="list-style-type: none">Fully underwritten A\$525m institutional placement to eligible investors under Evolution’s ASX Listing Rule 7.1 capacity (“Placement”)Approximately 138.2 million new fully paid ordinary shares (“New Shares”) to be issued under the Placement, representing approximately 7.5% of existing shares on issue
Offer price	<ul style="list-style-type: none">The Placement will be conducted at a price of A\$3.80 per New Share (“Offer Price”), representing an 8.2% discount to the close price of A\$4.14 per share as at 4 December 2023
Ranking	<ul style="list-style-type: none">New Shares issued under the Placement will rank pari passu with existing shares on issue
Share purchase plan (SPP)	<ul style="list-style-type: none">Non-underwritten SPP to raise up to A\$60m¹Eligible shareholders in Australia and New Zealand will be invited to apply for up to A\$30,000 of New Shares free of any brokerage, commission and transaction costsThe issue price for New Shares in the SPP will be the lesser of the Offer Price and a 2.5% discount to the 5-day volume weighted average price of Evolution shares traded up to, and including, the closing date of the SPP (being 16 January 2024)SPP offer booklet expected to be sent to eligible shareholders on 13 December 2023
Underwriting	<ul style="list-style-type: none">The Placement is fully underwritten by the underwriter²

USE OF FUNDS AND CAPITAL STRUCTURE

Sources and uses of funds

Sources	A\$m
Placement	525
New debt facility	200
Available cash ¹	30
Total sources	755

Uses	A\$m
Upfront cash	608
Estimated working capital adjustment	34
Stamp duty	66
Transaction costs	32
Integration cost	15
Total uses	755

Evolution's pro-forma capital structure²

Key metrics	Units	Evolution Standalone	Transaction funding	Evolution Pro-forma ⁷
Share price	A\$/sh	4.14	3.80	4.12
(x) Shares outstanding	m	1,840	138	1,978
Market Capitalisation (indicative)	A\$m	7,617	525	8,142
(-) Cash ³	A\$m	(79)	30	(49)
(+) Debt ^{3,4}	A\$m	1,807	200	2,007
Enterprise Value (indicative)⁵	A\$m	9,345	755	10,100⁸
Book value of equity (BV) ⁶	A\$m	3,389	-	3,914
Gearing (ND / ND + BV)	%	34%	-	34%

1. Cash on balance sheet and cash flow

2. Market data as at 4 December 2023

3. Cash, debt and Book Values as at 30 September 2023 (unaudited)

4. USPP debt converted to Australian dollars using cross currency swap rates

5. Enterprise value is defined as market capitalisation less cash plus debt

6. Impact of the transaction on Book Value of equity is net of transaction costs and stamp duty of A\$102m

7. Evolution pro-forma share price, market capitalisation and enterprise value are a hypothetical calculation assuming that the Placement is fully subscribed at the Offer Price and based on the market price of Evolution shares on 4 December 2023. These figures are not a prediction of what Evolution's share price, market capitalisation or enterprise value will be following completion of the Placement

8. Not inclusive of US\$356m Triple Flag stream obligation

EQUITY RAISING TIMETABLE

Event	Date ¹
Placement	
Trading halt and launch of Placement	5 December 2023
Trading halt lifted and announcement of completion of Placement	6 December 2023
Settlement of Placement Shares	8 December 2023
Allotment of Placement Shares	11 December 2023
Share Purchase Plan	
Record date for eligibility to participate in SPP	7pm, 4 December 2023
SPP offer open date and SPP booklet made available to eligible shareholders	13 December 2023
SPP closing date	16 January 2024
Announcement of SPP participation and results, and allotment of New Shares	23 January 2024

OUTSTANDING QUALITY PORTFOLIO

Ernest Henry (2040)¹

- Copper and gold exposure
- LOM supported by current feasibility study (Mar 2025)
- Extensive resource and reserve growth opportunity

Mt Rawdon

- Innovative option on transition to renewable energy source following resource depletion in ~18 months
- Investment decision – Dec 2024

Red Lake (2038)¹

- Targeting consistent production of ~200koz pa
- Stable cash generation

Northparkes (~2053)²

- Increases group copper and gold exposure
- Long history of stable cash generation
- Lower near-term capital intensity with mining method optionality

Mungari (2038)¹

- Current expansion project to double mill capacity, extend LOM to 2038 and lower AISC
- Commissioning on track (March 2026)

Cowal (2040)¹

- Production now supplemented by higher margin underground operations
- Expansion potential in open pit and underground mining

Asset legend

- Copper and gold
- Gold

— Accretive acquisition that improves quality of portfolio —



QUESTIONS



05

APPENDICES



APPENDIX: SUPPORTING MATERIALS

FY24E GUIDANCE¹

FY24 Guidance	Gold (oz) (+/-5%)	Copper (t) (+/-5%)	AISC (A\$/oz) ⁵ (+/-5%)	Sustaining Capital (A\$m)	Major Project Capital (A\$m)	Major Mine Development (A\$m)
Group	789,000	62,500	1,340	200 – 245	335 – 365	135 – 155
Northparkes^{2,3,4} (6 months to June 2024)	19,000	12,500	150	10 – 15	10 – 15	10 – 15
Cowal	320,000	-	1,250	40 – 50	85 – 90	~5
Ernest Henry	80,000	50,000	(2,000)	55 – 62.5	45 – 50	45 – 50
Red Lake	170,000	-	2,000	45 – 55	85 – 90	60 – 65
Mungari	130,000	-	1,930	45 – 52.5	110 – 120	15 – 20
Mt Rawdon	70,000	-	1,850	5 – 7.5		
Corporate				0 – 2.5		

1. Figures for Evolution represent Evolution's forecast FY24 production, capital expenditure and AISC. These forecasts are subject to a variety of risks, including unforeseen production interruptions, lower than expected grades and changes in input costs. Production, capital expenditure and AISC estimates including Northparkes have been provided for illustrative purposes only to indicate what Evolution's forecast FY24 production would have been if it had owned 80% of Northparkes for the periods indicated
2. Northparkes' FY24E forecast is based on Evolution's due diligence and information provided by CMOC
3. Northparkes production metrics presented on an 80% basis
4. Triple Flag's stream on Northparkes is a synthetic stream via a Hong Kong entity which is paid out on a percentage of the gold and silver referable to CMOC's 80% share of those metals from Northparkes
5. Combined AISC is calculated based on the weighted average of Evolution's FY24 AuEq production and reported AISC cost of A\$1,370/oz and Northparkes FY24 AuEq production and reported AISC of A\$150/oz

NORTHPARKES TIMELINE

Northparkes has a long history of delivering on growth and expansion

Discovery

1976

Discovered E22 by Peko-Wallsend (roadside traverse)

1978-80

RAB drilling discovered E27 and E26

1980's

(early) North merged with Peko and was known as North Broken Hill (NBH) and subsequently, in the 1990's became North Limited (NBH)

1992

Approved operation – open-cut, underground and mill

1993

JV formed with Sumitomo Parties – to facilitate concentrate purchase and processing

Growth

1993-94

First mining operation (UG block cave mining at E26 and open-cut mining at E27)

1994

Open cut mining commences at E22, first gold poured

2000

Rio Tinto acquires 80% in Northparkes

2004

Second block cave commissioned at E26 L2

2008

Extension to 2nd block cave mine at E26 L2N

2010

Initial production at E48 L1

Expansion

2012

Milling capacity expanded to 6.4Mtpa

2013

Rio Tinto sold 80% stake to CMOC for US\$820m¹

2019

Mill expanded to 7.6Mtpa, shaft capacity also increased in line as well

2020

CMOC entered into a streaming agreement with TFPM and received payment of US\$550m cash

2023 onwards

Evolution acquisition. Current LOM focused on 5 porphyry deposits suitable for caving and or open cut mining (E26, E48, E22, E31, GRP314)

MINING OVERVIEW

Underground operations

- **E48 first lift (E48L1)**
 - Commissioning completed in mid-2011 (block caving method)
 - 100% automated mining achieved in October 2015
 - E48 scheduled to be completed within EVN's FY24
 - E48 second lift (E48L2) is part of the LOM plan
 - Mining of E48 deposit will be stopped by end of December 2023 due to faster than expected grade decline

- **E26**
 - E26 mining areas comprised of L1, L2, L1N block caves and the E26SLC
 - Current mining is focused on E26SLC (commenced 2016) and E26L1N block cave (commenced 2022)
 - E26SLC consists of 4 sub levels with 2 more levels under development

Evolution's potential LOM scenario

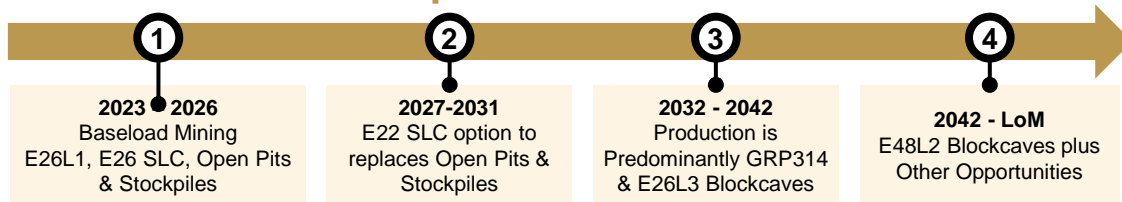

Equipment and site overview

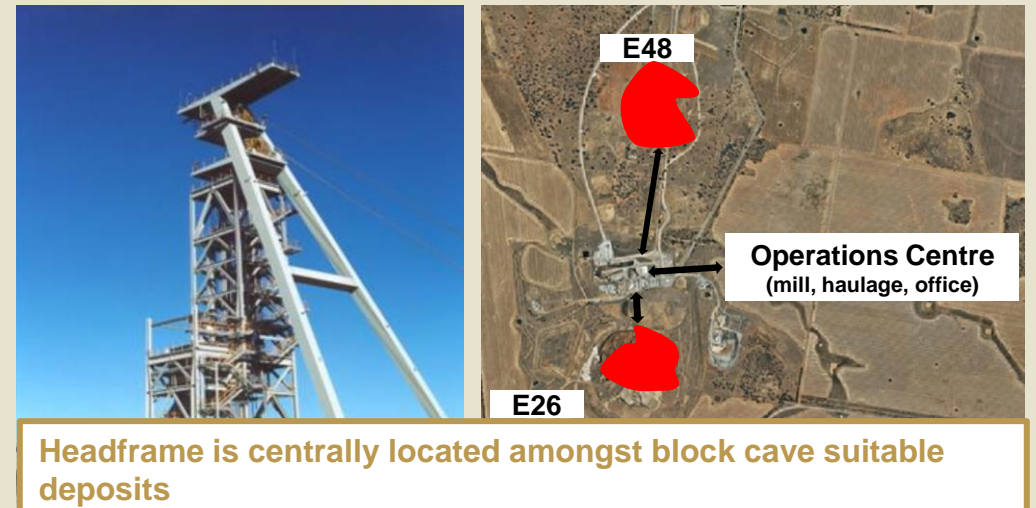

PROCESSING OVERVIEW

Processing overview

General

- Plant includes surface crusher, stockpiles, grinding mills, froth flotation area and storage
- Traditional sulphide flotation process is used to recover copper and precious metals into copper concentrate containing gold and silver
- Designed to process copper-gold oxide and sulphide ore
- New surface secondary crushing and screening facility installed with Sandvik crushers
- Average recovery of 83% Cu, 71% Au (YTD)¹

Logistics

- Concentrate is trucked / railed to Port of Newcastle and shipped to international clients

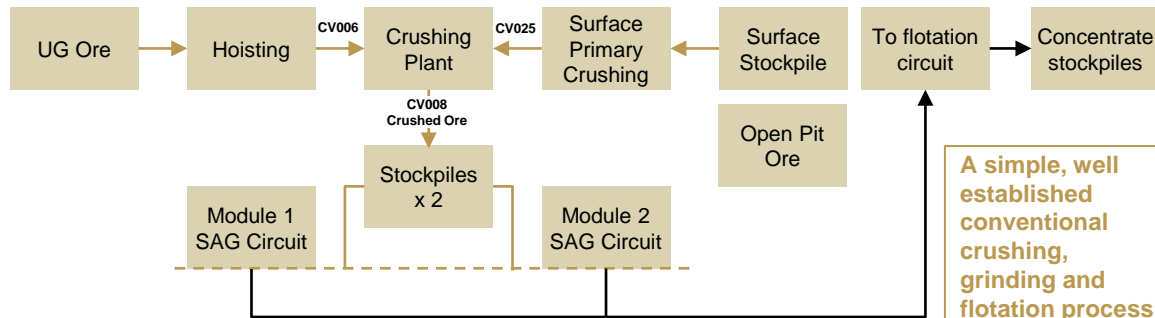

Processing plant



~\$200m
new surface
secondary
crushing and
screening
facility installed
recently

Historical ore milled (Mt 100% basis)

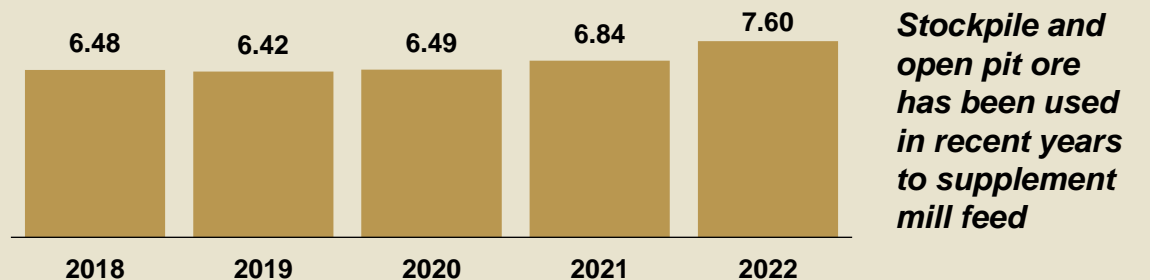

Northparkes has a consistent history of asset operating stability. Current mill capacity 7.6Mtpa

WATER AND SUPPORTING INFRASTRUCTURE

Abundant water supply and contracted power

- **Water supply**
 - Water sourced from onsite and offsite locations including imported water from various licenses
 - 11 water licenses from Forbes
 - 6.5GL annual water consumption in 2022 supplied with 2GL from external sources and 4.5GL from recycled onsite water storage facilities
- **Power requirements**
 - Site demand is relatively constant at ~32MW and there is sufficient infrastructure and supply agreements in place to serve current demand
 - The high voltage (HV) installation for NPM is connected to Essential Energy's (state owned) network via a 132kV feeder, emanating from the Transgrid's (operator) 132/66kV substation located in the township of Parkes
- **Emissions**
 - Northparkes' current total emissions are ~215,000 TCO₂-e / Annum consisting of Scope 1 and Scope 2 emissions

Power infrastructure and water supply

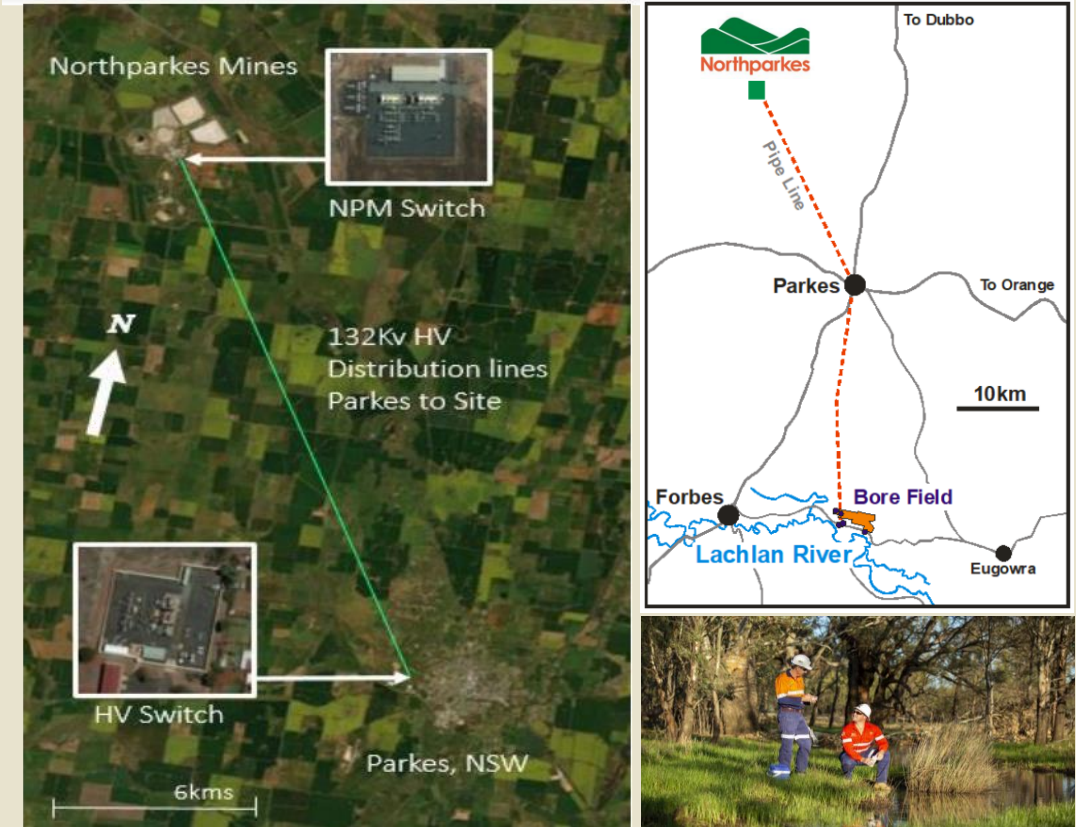

PEOPLE AND COMMUNITY

Northparkes people and community

- **Residential mine site**
 - Steady state workforce of 330
 - ~98% of workforce residing in the local government areas of Parkes and Forbes with very low staff turnover
- **Personnel and safety**
 - Turnover of 17% on a 12-month rolling average which is less than the Australian mining average
 - Female participation is 20% of the workforce
 - Reported FY22 TRIF: 10.7¹
- **Community initiatives**
 - Strong first nation and community connection
 - The Community Consultative Committee² meets a minimum of twice per year to update members on operations and receive community feedback
 - Northparkes' Community Investment Programs support various initiatives in health, economic development, education and youth which contribute to the Parkes and Forbes local government areas
 - Wiradjuri Executive³ committee meets four times a year to identify opportunities and develop projects to support the Wiradjuri people

Northparkes' community initiatives



330 direct employees

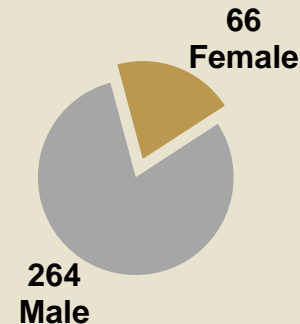

Strong local workforce based in Parkes and Forbes with low turnover

20%
Female workforce

98%
Residential staff

17%
Low staff turnover

ABBREVIATIONS

Abbreviation	Definition
A\$m	Australian dollars in millions
Ag	Silver
AISC	All-in Sustaining Cost
Au	Gold
AuEq	Gold equivalent
BC	Block cave
CMOC	CMOC Group Limited
Cu	Copper
CuEq	Copper equivalent
EVN	Evolution
FY	Financial year
GL	Giga litre
kt	Thousand tonne
LTM	Last twelve months
Mt	Million tonne
NPM	Northparkes
oz	Troy ounce
pa	Per annum
P&L	Profit and loss
sh	share
SLC	Sub-level cave
SPP	Share purchase plan
t	Tonne
TFPM	Triple Flag Precious Metals Corp
US\$m	US dollars in millions
YTD	Year to date





APPENDIX: MINERAL RESOURCE AND ORE RESERVE

GROUP GOLD MINERAL RESOURCES AT 31 DECEMBER 2022

(WITH ERNEST HENRY JUNE 2023 MINERAL RESOURCE UPDATE)

Gold			Measured			Indicated			Inferred			Total Resource			CP ⁷
Project	Type	Cut-off (g/t Au)	Tonnes (Mt)	Gold Grade (g/t)	Gold Grade (g/t)	Tonnes (Mt)	Gold Grade (g/t)	Gold Metal (koz)	Tonnes (Mt)	Gold Grade (g/t)	Gold Metal (koz)	Tonnes (Mt)	Gold Grade (g/t)	Gold Metal (koz)	
Cowal ¹	Open pit	0.35	29.5	0.46	440	182.9	0.86	5,033	26.5	0.80	682	238.9	0.80	6,155	1
Cowal	UG	1.50	-	-	-	22.0	2.49	1,760	12.4	2.33	925	34.4	2.43	2,685	1
Cowal¹	Total		29.5	0.46	440	204.9	1.03	6,793	38.8	1.29	1,607	273.3	1.01	8,840	1
Red Lake²	Total	2.5-3.3	-	-	-	35.7	6.66	7,639	24.8	5.90	4,702	60.4	6.35	12,342	2
Mungari ^{1,3}	Open pit	0.31-0.34	-	-	-	53.8	1.08	1,864	24.0	1.16	894	77.8	1.10	2,758	3
Mungari ^{1,4}	UG	1.46-2.44	1.4	4.66	205	9.7	4.28	1,332	8.7	3.74	1,043	19.7	4.07	2,580	3
Mungari¹	Total		1.4	4.66	205	63.5	1.57	3,196	32.7	1.84	1,937	97.5	1.70	5,338	3
Mt Rawdon¹	Total	0.23	5.5	0.30	54	21.0	0.58	389	2.3	0.48	35	28.8	0.52	478	4
Ernest Henry^{5,6}	Total	N/A²	35.0	0.75	847	35.0	0.76	852	31.5	0.66	668	101.5	0.73	2,368	5
Marsden	Total	0.20	-	-	-	119.8	0.27	1,031	3.1	0.22	22	123.0	0.27	1,053	1
Total			71.4	0.67	1,546	479.9	1.29	19,901	133.2	2.09	8,972	684.5	1.38	30,419	

Data is reported to significant figures to reflect appropriate precision and may not sum precisely due to rounding. "UG" denotes underground Mineral Resources are reported inclusive of Ore Reserves

1. Includes stockpiles

2. Red Lake Mineral Resource cut-off varies from 2.5g/t Au to 3.3g/t Au and is dependent on deposit and location from surface and processing plant

3. Mungari Open Pit Mineral Resource cut-offs vary from 0.31g/t Au to 0.34g/t Au. The average open pit cut-off is 0.32g/t Au

4. Mungari Underground Mineral Resource cut-offs vary from 1.46g/t Au to 2.44g/t Au per deposit. The average underground cut-off is 1.96g/t Au

5. Ernest Henry Operations reported Mineral Resources are reported within an interpreted 0.7% Cu mineralised envelope

6. Ernest Henry reported Mineral Resource estimate is depleted to 30 June 2023

7. Group Gold Mineral Resources Competent Person (CP) Notes refer to 1. James Biggam; 2. Jason Krauss; 3. Brad Daddow; 4. Matthew Graham-Ellison; 5. Phil Micale

This information is extracted from the releases titled 'Annual Mineral Resources and Ore Reserves Statement' dated 16 February 2023, "Mungari Mine Life Extended to 15 Years at 10 to 20% lower AISC" dated 5 June 2023 and "Further Increase in Ernest Henry Mineral Resource" dated 17 August 2023 available to view at www.evolutionmining.com.au. The Company confirms that it is not aware of any new information or data that materially affects the information included in the release and that all material assumptions and parameters underpinning the estimates in the release continue to apply and have not materially changed. The Company confirms that the form and context in which the Competent Persons' findings are presented have not been materially modified from the Reports

GROUP GOLD ORE RESERVES AT 31 DECEMBER 2022

(WITH ERNEST HENRY JUNE 2023 ORE RESERVE UPDATE)

Gold			Proved			Probable			Total Reserve			CP ⁹
Project	Type	Cut-off (g/t Au)	Tonnes (Mt)	Gold Grade (g/t)	Gold Metal (koz)	Tonnes (Mt)	Gold Grade (g/t)	Gold Metal (koz)	Tonnes (Mt)	Gold Grade (g/t)	Gold Metal (koz)	
Cowal ^{1,2}	Open pit	0.45	27.4	0.47	414	86.2	0.99	2,745	113.6	0.87	3,160	1
Cowal ³	UG	0.55/1.80	-	-	-	15.9	2.29	1,169	15.9	2.29	1,169	2
Cowal	Total		27.4	0.47	414	102.1	1.19	3,915	129.5	1.04	4,329	
Red Lake⁴	Total	2.5-4.0	-	-	-	13.0	6.90	2,878	13.0	6.90	2,878	3
Mungari ⁵	UG	2.2-3.8	0.4	5.47	78	3.2	4.41	457	3.7	4.54	535	4
Mungari ^{1,6}	Open pit	0.57-0.74	-	-	-	20.7	1.06	703	20.7	1.06	703	4
Mungari¹	Total		0.4	5.47	78	23.9	1.51	1,160	24.3	1.58	1,238	
Mt Rawdon¹	Open pit	0.31	1.9	0.40	25	9.0	0.66	191	10.9	0.61	216	5
Ernest Henry^{7,8}	UG	0.50-0.75% CuEq	26.5	0.62	527	50.9	0.36	582	77.4	0.45	1,109	6
Marsden	Open pit	0.30	-	-	-	65.2	0.39	817	65.2	0.39	817	7
	Total		56.2	0.58	1043	264.0	1.12	9,544	320.3	1.03	10,587	

Data is reported to significant figures to reflect appropriate precision and may not sum precisely due to rounding. "UG" denotes underground

1. Includes stockpiles

2. Ore Reserve has been updated for E42 Stage H Open Pit in line with 2022 corporate commodity price assumptions, updated modifying factors and allowing for depletion. All remaining 'Open Pit Continuation' Ore Reserves (OPC) are declared as per December 2021 Cowal Open Pit Ore Reserves. The OPC Ore Reserve will be updated at the completion of the OPC Feasibility Study ('FS'). Modifying factors to be updated during the FS include Mineral Resource, geotechnical, metallurgical, revenue and cost assumptions. To date, no fatal flaws have been identified during the FS. A materiality test was conducted on the impact of the change between the December 2021 and December 2022 Mineral Resource model on the OPC Ore Reserve, the change is expected to be less than 10%

3. Cowal Underground Ore Reserve has been optimised using a \$1,600/oz price assumption, economically tested at up to \$2,200/oz and considers updated modifying factors and depletion. The Cowal Underground Ore Reserve includes development material at an incremental cut-off grade of 0.55g/t Au

4. Red Lake Ore Reserve cut-off is 4.0g/t Au except for HG Young (3.0g/t Au) and Upper Campbell (2.5g/t Au)

5. Mungari Underground Ore Reserve cut-off varies from 2.2g/t Au to 3.8g/t Au and is dependent on specific deposits and varies between each underground mine taking into account location and costs

6. Mungari Open Pit Ore Reserves were optimised using a \$1,600/oz gold price assumption. The exceptions are the Paradigm and Castle Hill open pit operations which have been scheduled for production between 2023 and 2025 and have been optimised with a \$2,200/oz gold price assumption. Cut-offs vary by deposit from 0.57g/t Au to 0.74g/t Au and take into account location and costs

7. Ernest Henry reported Ore Reserve estimate is based on the December 2022 Mineral Resource detailed in the ASX Release titled "Annual Mineral Resources and Ore Reserves Statement" dated 16 Feb 2023 and available to view at www.evolutionmining.com.au. The applied flow model cut-off grades of 0.50 % and 0.75% copper equivalent ('CuEq') are determined through an economic evaluation process which considers the Net Smelter Return (NSR) and operating costs. The utilised copper equivalent equation is: CuEq = Cu + Au NSR/56.4 where; Au NSR = 38.5 * Au - 0.04

8. Ernest Henry reported Ore Reserve estimate is depleted to 30 June 2023

9. Group Gold Ore Reserve Competent Person (CP) Notes refer to 1. Dean Basile (Mining One); 2. Ryan Bettcher; 3. Brad Armstrong; 4. Blake Callinan; 5. Ben Young; 6. Michael Corbett; 7. Anton Kruger

This information is extracted from the releases titled 'Annual Mineral Resources and Ore Reserves Statement' dated 16 February 2023, "Mungari Mine Life Extended to 15 Years at 10 to 20% lower AISC" dated 5 June 2023 and "Ernest Henry Mine Life Extended to 2040 and Ore Reserves Doubled" dated 5 June 2023 available to view at www.evolutionmining.com.au. The Company confirms that it is not aware of any new information or data that materially affects the information included in the release and that all material assumptions and parameters underpinning the estimates in the release continue to apply and have not materially changed. The Company confirms that the form and context in which the Competent Persons' findings are presented have not been materially modified from the Reports

GROUP RESOURCES & RESERVES AT 31 DECEMBER 2022

(WITH ERNEST HENRY JUNE 2023 ORE RESERVE AND MINERAL RESOURCE UPDATES)

Group Mineral Resource – contained copper

Copper			Measured			Indicated			Inferred			Total Resource			CP ³
Project	Type	Cut-off	Tonnes (Mt)	Copper Grade (%)	Copper Metal (kt)	Tonnes (Mt)	Copper Grade (%)	Copper Metal (kt)	Tonnes (Mt)	Copper Grade (%)	Copper Metal (kt)	Tonnes (Mt)	Copper Grade (%)	Copper Metal (kt)	
Marsden	Total	0.2g/t Au	-	-	-	119.8	0.46	553	3.1	0.24	7	123.0	0.46	560	1
Ernest Henry ^{1,2}	Total	0.7% Cu	35.0	1.31	458	35.0	1.29	450	31.5	1.15	363	101.5	1.25	1,271	2
Total			35.0	1.31	458	154.8	0.65	1,003	34.6	1.07	370	224.4	0.82	1,831	

Data is reported to significant figures to reflect appropriate precision and may not sum precisely due to rounding

1. Ernest Henry Operations reported Mineral Resources are reported within an interpreted 0.7% Cu mineralised envelope

2. Ernest Henry reported Mineral Resource estimate is depleted to 30 June 2023

3. Group Mineral Resources Competent Person (CP) Notes refer to: 1. James Biggam; 2. Phil Micale

Group Ore Reserve – contained copper

Copper			Proved			Probable			Total Reserve			CP ⁵
Project	Type	Cut-Off	Tonnes (Mt)	Copper Grade (%)	Copper Metal (kt)	Tonnes (Mt)	Copper Grade (%)	Copper Metal (kt)	Tonnes (Mt)	Copper Grade (%)	Copper Metal (kt)	
Marsden	Total	0.3g/t Au	-	-	-	65.2	0.57	371	65.2	0.57	371	1
Ernest Henry ^{3,4}	Total	0.50-0.75% CuEq	26.5	1.08	287	50.9	0.59	302	77.4	0.76	589	2
Total			26.5	1.08	287	116.1	0.58	673	142.6	0.67	960	

Data is reported to significant figures to reflect appropriate precision and may not sum precisely due to rounding

3. Ernest Henry reported Ore Reserve estimate is based on the December 2022 Mineral Resource detailed in the ASX Release titled "Annual Mineral Resources and Ore Reserves Statement" dated 16 Feb 2023 and available to view at www.evolutionmining.com.au. The applied flow model cut-off grades of 0.50 % and 0.75% copper equivalent ('CuEq') are determined through an economic evaluation process which considers the Net Smelter Return (NSR) and operating costs. The utilised copper equivalent equation is: $CuEq = Cu + Au \text{ NSR}/56.4$ where; $Au \text{ NSR} = 38.5 * Au - 0.04$

4. Ernest Henry reported Ore Reserve estimate is depleted to 30 June 2023

5. Group Ore Reserve Competent Person (CP) Notes refer to: 1. Anton Kruger; 2. Michael Corbett

This information is extracted from the releases titled 'Annual Mineral Resources and Ore Reserves Statement' dated 16 February 2023, "Ernest Henry Mine Life Extended to 2040 and Ore Reserves Doubled" dated 5 June 2023 and "Further Increase in Ernest Henry Mineral Resource" dated 17 August 2023 available to view at www.evolutionmining.com.au. The Company confirms that it is not aware of any new information or data that materially affects the information included in the release and that all material assumptions and parameters underpinning the estimates in the release continue to apply and have not materially changed. The Company confirms that the form and context in which the Competent Persons' findings are presented have not been materially modified from the Reports

NORTHPARKES MINERAL RESOURCES AS AT 31 DECEMBER 2022

Northparkes – Mineral Resource

Deposit	Measured				Indicated				Inferred				Total Resources				Total Contained Metal		
	Tonnes (Mt)	Copper Grade (%)	Gold Grade (g/t)	Silver Grade (g/t)	Tonnes (Mt)	Copper Grade (%)	Gold Grade (g/t)	Silver Grade (g/t)	Tonnes (Mt)	Copper Grade (%)	Gold Grade (g/t)	Silver Grade (g/t)	Tonnes (Mt)	Copper Grade (%)	Gold Grade (g/t)	Silver Grade (g/t)	Copper Metal (Mt)	Gold Metal (Moz)	Silver Metal (Moz)
E22	10.2	0.43	0.29	2.06	4.8	0.37	0.19	1.52	0.4	0.35	0.19	1.31	15.39	0.41	0.26	1.87	0.06	0.13	0.93
E48L1	-	-	-	-	-	-	-	-	-	-	-	-	-	-	-	-	-	-	-
E48L2	90.2	0.54	0.25	1.91	67.4	0.51	0.17	1.77	-	-	-	-	157.60	0.53	0.22	1.85	0.83	1.09	9.37
E26L2 Residual	-	-	-	-	11.5	0.78	0.15	2.07	-	-	-	-	11.48	0.78	0.15	2.07	0.09	0.06	0.76
E26L3	111.8	0.62	0.15	1.82	49.8	0.53	0.12	1.54	-	-	-	-	161.60	0.59	0.15	1.74	0.96	0.75	9.02
GRP314L1	-	-	-	-	23.0	0.57	0.12	1.74	22.2	0.59	0.14	1.80	45.20	0.58	0.13	1.77	0.26	0.19	2.57
GRP314L2	-	-	-	-	46.5	0.54	0.17	1.67	34.8	0.56	0.22	1.60	81.30	0.55	0.19	1.64	0.45	0.50	4.29
MJH	34.6	0.6	0.1	1.5	7.5	0.5	0.1	1.3	-	-	-	-	42.04	0.57	0.11	1.49	0.24	0.15	2.01
E44 – Sulphide	4.9	0.03	1.51	10.45	2.6	0.03	1.24	7.77	0.15	0.03	1.20	9.4	7.59	0.03	1.42	9.53	-	0.35	2.33
E44 – Oxide	0.7	0.03	0.97	5.78	0.5	0.03	0.99	4.33	0.04	0.02	1.01	2.4	1.16	0.03	0.98	5.10	-	0.04	0.19
E31 – Sulphide	3.4	0.37	0.42	1.34	-	-	-	-	-	-	-	-	3.41	0.37	0.42	1.34	0.01	0.05	0.15
E31 – Oxide	0.1	0.24	0.67	0.70	-	-	-	-	-	-	-	-	0.10	0.24	0.67	0.70	-	-	-
Total	255.9	0.56	0.22	1.99	213.4	0.53	0.16	1.77	57.5	0.57	0.19	1.70	526.86	0.55	0.19	1.87	2.91	3.29	31.6

Data is reported to significant figures to reflect appropriate precision and may not sum precisely due to rounding;

Reported Mineral Resource is exclusive of reported Ore Reserve and includes all blocks contained within mine design shapes developed on an equivalent copper (ECu) cutoff grade which takes into account the estimated Au and Cu grades within each block;

$ECu = ((NSRCu * Cu \text{ grade } (\%) * Cu \text{ Recovery}) + (NSRAu * Au \text{ Grade } (g/t) * Au \text{ Recovery}) / (NSRCu * Cu \text{ grade } (\%) * Cu \text{ Recovery})) * Cu \text{ Grade } (\%)$ where NSRCu is the net smelter return of 1% copper in 1 tonne of ore and NSRAu is the net smelter return of Au of 1g/t Au in 1 tonne of ore;

Investors should also note that the reporting of resource and reserve estimates for Northparkes ("CMOC's Estimates") are not reported in accordance with the JORC Code 2012. A Competent Person has not done sufficient work to classify CMOC's Estimates as Mineral Resources and Ore Reserves in accordance with the JORC Code. It is possible that following evaluation and/or further exploration work CMOC's Estimates may materially change and hence will need to be reported afresh under and in accordance with the JORC Code. Nothing has come to Evolution's attention that causes it to question the accuracy or reliability of CMOC's Estimates, but Evolution has not independently validated CMOC's Estimates and therefore is not to be regarded as reporting, adopting or endorsing those estimates. For more information as to CMOC's Estimate, please refer to Evolution's ASX announcement entitled "ACQUISITION OF AN 80% INTEREST IN NORTHPARKES COPPER-GOLD MINE AND A\$525 MILLION EQUITY RAISING" released 5 December 2023 and available to view at www.evolutionmining.com.au;

NORTHPARKES ORE RESERVES AS AT 31 DECEMBER 2022

Northparkes – Ore Reserves

Deposit	Proven				Probable				Total Reserves				Contained Metal			Recovery			CMOC 80% Share			
	Tonnes (Mt)	Copper Grade (%)	Gold Grade (g/t)	Silver Grade (g/t)	Tonnes (Mt)	Copper Grade (%)	Gold Grade (g/t)	Silver Grade (g/t)	Tonnes (Mt)	Copper Grade (%)	Gold Grade (g/t)	Silver Grade (g/t)	Tonnes (Mt)	Copper Metal (%)	Gold Metal (g/t)	Silver (%)	Copper (%)	Gold (%)	Silver (%)	Copper Metal (Mt)	Gold Metal (Moz)	Silver Metal (Moz)
Oxide	-	-	-	-	-	-	-	-	-	-	-	-	-	-	-	-	-	-	-	-	-	-
Sulphide	4.6	0.33	0.17	0.72	-	-	-	-	4.6	0.33	0.17	0.72	0.01	0.03	0.11	84	79	62	0.01	0.02	0.05	
Total Stockpiles	4.6	0.33	0.17	0.72	-	-	-	-	4.6	0.33	0.17	0.72	0.01	0.03	0.11	84	79	62	0.01	0.02	0.05	
E31N Sulphide	3.6	0.29	0.69	0.82	-	-	-	-	3.6	0.29	0.69	0.82	0.01	0.08	0.09	87	68	68	0.01	0.04	0.05	
E31N Oxide	1.2	0.34	1.1	0.95	-	-	-	-	1.2	0.34	1.10	0.95	-	0.04	0.04	18	54	54	-	0.02	0.02	
E31 Sulphide	1.7	0.51	0.47	1.86	0.4	0.39	0.29	1.30	2.1	0.49	0.44	1.76	0.01	0.03	0.12	88	82	82	0.01	0.02	0.08	
E28NE Sulphide	5.9	0.34	0.28	0.97	-	-	-	-	5.9	0.34	0.28	0.97	0.02	0.05	0.18	88	82	82	0.01	0.04	0.12	
Total Open Cut	12.4	0.35	0.51	1.05	0.4	0.39	0.29	1.30	12.8	0.35	0.50	1.05	0.04	0.21	0.43	81	71	76	0.03	0.12	0.26	
E22	-	-	-	-	42.4	0.52	0.39	2.45	42.4	0.52	0.39	2.45	0.22	0.53	3.34	87	73	62	0.15	0.31	1.66	
E26	9.8	0.74	0.17	1.94	30.5	0.57	0.07	1.65	40.3	0.62	0.09	1.72	0.25	0.12	2.23	88	73	62	0.17	0.07	1.11	
E48	1.3	0.29	0.05	-	-	-	-	-	1.3	0.29	0.05	-	-	-	-	88	76	62	-	-	-	
Total Underground	11.1	0.69	0.15	1.71	72.9	0.55	0.25	2.12	84.0	0.56	0.24	2.06	0.47	0.65	5.57	87	73	62	0.33	0.38	2.76	
Total	28.1	0.48	0.31	1.25	73.2	0.54	0.26	2.11	101.4	0.53	0.27	1.87	0.53	0.88	6.11	87	73	63	0.37	0.51	3.08	

Data is reported to significant figures to reflect appropriate precision and may not sum precisely due to rounding;

Reported Ore Reserve includes all blocks contained within mine design shapes plus expected dilution from the block caving mining approach. Mine designs have been developed on an equivalent copper (ECu) cutoff grade which takes into account the estimated Au and Cu grades and associated expected metallurgical recovery within each block;

$ECu = ((NSRCu * Cu \text{ grade } (\%) * Cu \text{ Recovery}) + (NSRAu * Au \text{ Grade } (g/t) * Au \text{ Recovery}) / (NSRCu * Cu \text{ grade } (\%) * Cu \text{ Recovery})) * Cu \text{ Grade } (\%)$ where NSRCu is the net smelter return of 1% copper in 1 tonne of ore and NSRAu is the net smelter return of Au of 1g/t Au in 1 tonne of ore;

Investors should also note that the reporting of resource and reserve estimates for Northparkes ("CMOC's Estimates") are not reported in accordance with the JORC Code 2012. A Competent Person has not done sufficient work to classify CMOC's Estimates as Mineral Resources and Ore Reserves in accordance with the JORC Code. It is possible that following evaluation and/or further exploration work CMOC's Estimates may materially change and hence will need to be reported afresh under and in accordance with the JORC Code. Nothing has come to Evolution's attention that causes it to question the accuracy or reliability of CMOC's Estimates, but Evolution has not independently validated CMOC's Estimates and therefore is not to be regarded as reporting, adopting or endorsing those estimates. For more information as to CMOC's Estimate, please refer to Evolution's ASX announcement entitled "ACQUISITION OF AN 80% INTEREST IN NORTHPARKES COPPER-GOLD MINE AND A\$25 MILLION EQUITY RAISING" released 5 December 2023 and available to view at www.evolutionmining.com.au;

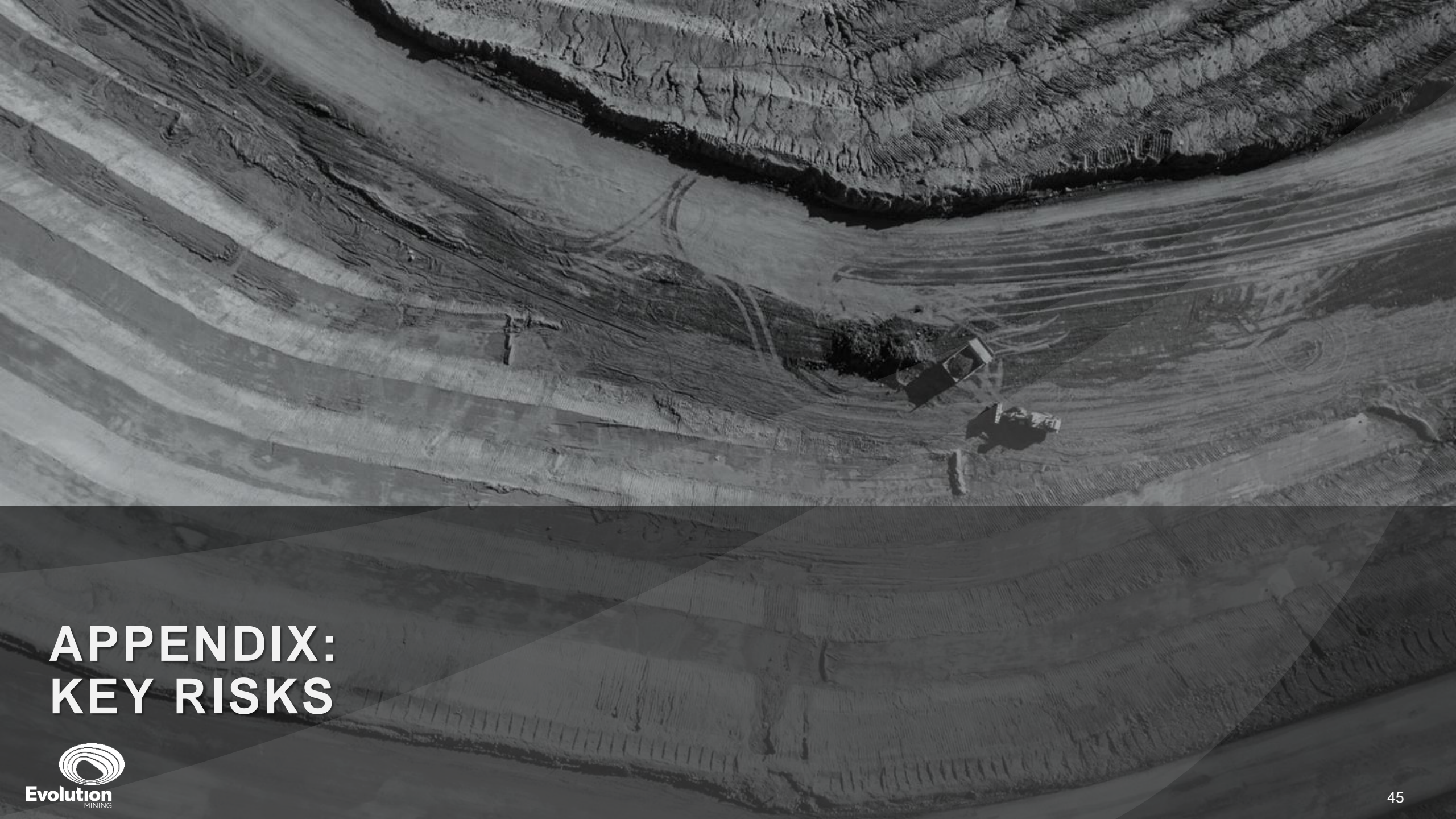

APPENDIX: KEY RISKS

KEY RISKS - GENERAL

There are various risks associated with investing in Evolution, as with any stock market investment. This section sets out:

- existing business and operational risks for Evolution - these risks are generally common to gold, silver and copper mining operators in Australia, including the Northparkes Mine, and therefore they will be risks to which Evolution will continue to be exposed including if it completes the proposed Transaction;
- risks specific to the Transaction; and
- offer and share investment risks.

Potential investors should consider whether the securities offered are a suitable investment having regard to their own personal investment objectives and financial circumstances and the risk factors set out below. Evolution has implemented appropriate strategies, actions, systems and safeguards for known risks; however, some are outside its control. While some common risk factors are set out below, it is not possible to produce an exhaustive list. The Evolution Directors recommend that potential investors consult their professional advisers before making any investment decisions.

Production and cost estimates

- The ability of Evolution to achieve production targets or meet operating and capital expenditure estimates on a timely basis cannot be assured. The assets of Evolution, as any others, are subject to uncertainty with ore tonnes, grade, metallurgical recovery, ground conditions, operational environment, funding for development, regulatory changes, accidents, other unforeseen circumstances such as unplanned mechanical failure of plant or equipment or pandemics, such as COVID-19.
- Evolution prepares estimates of future production and associated operating and capital costs for its operations. No assurance can be given that such estimates will be achieved. Failure to achieve production or cost estimates or material increases in costs could have an adverse impact on Evolution's future cash flows, profitability, results of operations and financial condition.
- Costs of production may also be affected by a variety of factors, including: changing waste-to-ore ratios; ore grade metallurgy; labour and other input costs; general inflationary pressures and currency exchange rates. Labour costs may increase significantly as a result of any increased labour shortages.
- The outbreak of another pandemic, or the failure to respond to pandemics (such as COVID-19) or other operational incidents within Evolution may also result in increased production costs.

Ore Reserves and Mineral Resources

- Ore Reserves and Mineral Resources are estimates only and are expressions of judgement based on industry practice, experience and knowledge. Estimates of Ore Reserves and Mineral Resources are necessarily imprecise and depend to some extent on interpretations which may prove inaccurate. No assurance can be given that the estimated Ore Reserves and Mineral Resources are accurate or that the indicated level of copper, gold, silver or any other mineral will be produced. Such estimates are, in large part, based on interpretations of geological data obtained from drill holes and other sampling techniques. Actual mineralisation or geological conditions may be different from those predicted. No assurance can be given that any or all of Mineral Resources constitute or will be converted into Ore Reserves. Actual Ore Reserves and Mineral Resources may differ from those estimated, which could have a positive or negative effect on Evolution's financial performance.
- Northparkes' Mineral Reserves and Mineral Resources have not been reported by CMOC in accordance with the JORC Code 2012. Whilst nothing has come to Evolution's attention that causes it to question the accuracy or reliability of CMOC's estimates, Evolution has not independently validated CMOC's estimates and therefore is not to be regarded as reporting, adopting or endorsing those estimates. There is a risk that following further evaluation work that CMOC's estimates may materially change, which could in turn have a positive or negative effect on Evolution's financial performance.
- Commodity price fluctuations as well as increased production and capital costs may render Evolution's Ore Reserves unprofitable to develop at a particular site or sites for periods of time or may render Ore Reserves containing relatively lower grade mineralisation uneconomic. Estimated Ore Reserves may have to be recalculated based on actual production experience. Any of these factors may require Evolution to reduce its Ore Reserves and Mineral Resources, which could have a negative impact on Evolution's financial results and the expected operating life of its mines.

Replacement of Ore Reserves

- Evolution must continually replace reserves depleted by production to maintain production levels over the long term. Reserves can be replaced by expanding known ore bodies, locating new deposits or making acquisitions. There is a risk that depletion of reserves will not be offset by discoveries or acquisitions or that divestitures of assets will lead to a lower reserve base. The reserve base of Evolution may decline if reserves are mined without adequate replacement and Evolution may not be able to sustain production beyond the current mine lives, based on current production rates.
- Exploration is highly speculative in nature. Evolution's exploration projects involve many risks and are frequently unsuccessful. There is no assurance that current or future exploration programs will be successful. Additionally, if a discovery is made, it may take several years from the initial phases of drilling until production is possible and there can be no guarantee that any discovery will ultimately result in mining operations being commenced in relation to that discovery.

Mining risks

- The mining industry is subject to significant risks and hazards, including environmental hazards, industrial incidents, unusual or unexpected geological and geotechnical difficulties, unavailability of materials and equipment, pit wall failures, rock bursts, seismic events, cave-ins, and weather conditions (including flooding and bush fires), most of which are beyond Evolution's control. These risks and hazards could result in significant costs or delays that could have a material adverse effect on Evolution's financial performance, liquidity and results of operation.

KEY RISKS - GENERAL

Fluctuations in gold, silver and copper prices

- Evolution's revenues are exposed to fluctuations in gold, silver and copper prices. Volatility in these prices creates revenue uncertainty and requires careful management of business performance to ensure that operating cash margins are maintained despite a fall in the prices payable for those metals. The risks associated with such fluctuations and volatility may be minimised by any hedging Evolution may undertake.
- Declining gold, silver and copper prices can also impact operations by requiring a reassessment of the feasibility of mine plans and certain projects and initiatives. The development of new ore bodies, commencement and timing of open pit cutbacks, commencement of development projects and the ongoing commitment to exploration projects can all potentially be impacted by a decline in the prevailing prices payable for those metals. Even if a project is ultimately determined to be economically viable, the need to conduct such a reassessment could potentially cause substantial delays and/or may interrupt operations, which may have a material adverse effect on Evolution's results of operations and financial condition.

Financial risks

- Evolution's activities and capital structure expose it to a variety of financial risks such as market risk (including interest rate risk and price risk), credit risk and liquidity risk. Evolution's overall risk management program focuses on the unpredictability of financial markets and seeks to minimise potential adverse effects on the financial performance of Evolution. If such financial risks eventuate or are unable to be managed effectively, they may have an adverse impact on Evolution's financial performance.

Hedging risk

- Evolution has hedging agreements in place for the forward sale of fixed quantities of gold production from its operations. There is a risk that Evolution may not be able to deliver the amount of gold required under its hedging arrangements if, for example, there is a production shortage. In this event, Evolution's financial performance may be adversely affected.
- Under the hedging agreements, rising gold prices could result in part of Evolution's gold production being sold at less than the prevailing spot price at the time of sale.

Foreign exchange rate risk

- Evolution is an Australian business that reports in Australian dollars. Evolution's revenue is derived from the sale of gold, silver and copper in a mix of US, Canadian and Australian dollars, whereas costs are mainly incurred by the businesses in Australian and Canadian dollars. Therefore, movements in the AUD/USD; USD/CAD and AUD/CAD exchange rates may adversely or beneficially affect Evolution's financial performance. The risks associated with such fluctuations and volatility may be minimised by any currency hedging Evolution may undertake though there is no assurance as to the efficacy of such currency hedging. Evolution's current policy is that it does not hedge foreign exchange risk on unhedged gold, copper and silver sales.

Taxation risk

- Change to tax legislation, the interpretation of tax legislation by the courts, the administration of tax legislation by the relevant tax authorities and the applicability of such legislation to Evolution or entities within the group may increase Evolution's tax liabilities.

Environmental risks

- Mining and exploration can be potentially environmentally hazardous, giving rise to potentially substantial costs for environmental rehabilitation, damage control and losses. Evolution is subject to environmental laws and regulations in connection with its operations and could be subject to liability due to risks inherent in its activities, including unforeseen circumstances.

Climate change risk

- Evolution has exposure to a range of climate change risks. The impacts of climate change may affect political, policy and legal developments, technology, Evolution's assets, the costs of inputs and raw materials, its productivity (due to potentially increased costs of capital), the markets for its products, the communities in which Evolution operates and Evolution's reputation.
- Non-physical risks arise from a variety of policy, regulatory, legal, technology, financial and market responses to the challenges posed by climate change and the transition to a lower-carbon economy. Any changes to government regulation or policy relating to climate change, including net zero initiatives or other regulation or policy relating to greenhouse gas emissions or energy intensive assets, may directly or indirectly impact the Evolution's costs and operational efficiency.
- Acute physical risks include increased severity of extreme weather events and chronic risks may also result from longer-term changes in climate patterns.
- Gold, silver and copper mining operations are energy intensive and in the short term, Evolution expects to continue to rely on fossil fuels. The use of renewable power generation and low emission technologies may adversely impact Evolution's operating and financial condition.

Regulatory risks

- Evolution's operations are subject to various Federal, State, Provincial and local laws and plans including those relating to mining, prospecting, development, permit and licence requirements, industrial relations, environment, land use, royalties, water, native title and cultural heritage, land access, mine safety and occupational health.
- Approvals, licences, permits and other regulatory approvals required to comply with such rules may, in some instances, be subject to the discretion of the applicable government or government officials, and, in some cases, the local community. No assurance can be given that Evolution will be successful in obtaining any, or all, of the various approvals, licences and permits or maintaining such authorisations in full force and effect without modification or revocation. To the extent such approvals are required and not retained or obtained in a timely manner or at all, Evolution may be curtailed or prohibited from continuing or proceeding with production and exploration.
- For example, native title claims or issues on any existing or future tenements held by Evolution may potentially impact Evolution's operations and future plans. For tenements that may still be subject to native title claims to be validly granted (or renewed), there are established statutory regimes that will need to be followed in connection with those tenements.

KEY RISKS - GENERAL

Water sources

- The effects of changes in rainfall patterns, water shortages and changing storm patterns and intensities may adversely impact the costs, production levels and financial performance of Evolution's operations. There is no guarantee that there will be sufficient future rainfall to support Evolution's future water demands in relation to its sites and operations, and this could adversely affect production and Evolution's ability to develop or expand projects and operations in the future. In addition, there can be no assurance that Evolution will be able to obtain alternative water sources on commercially reasonable terms or at all in the event of prolonged drought conditions.

Weather conditions

- Some of Evolution's sites and operations may be subject from time to time by severe storms and high rainfall leading to flooding and associated damage which may result in delays to or loss of production.

Insurance risk

- Evolution maintains insurance coverage as determined appropriate by its board and management, but no assurance can be given that Evolution will continue to be able to obtain such insurance coverage at reasonable rates (or at all), or that any coverage it obtains will be adequate and available to cover all claims.

KEY RISKS - TRANSACTION

Completion

- There is no certainty that the Transaction will occur. While there are no conditions precedent to the Share Sale and Purchase Agreement, completion of the Transaction, and the ability of Evolution to achieve its stated objectives, will depend on the performance by the vendor and certain third parties of various pre-completion obligations. Under the terms of the Share Sale and Purchase Agreement, if Evolution is unable to demonstrate that it has the funds to pay the purchase price within five business days of signing the Share Sale and Purchase Agreement, then Evolution may be required to pay a liquidated damages sum to the vendor of US\$40 million (noting this will only arise where the vendor terminates the Share Sale and Purchase Agreement for Evolution's failure to demonstrate committed funding).
- Likewise, under the terms of the Share Sale and Purchase Agreement if either Evolution or the vendor fail to satisfy their completion deliverables due to circumstances that are outside the relevant party's power and control, then the relevant party may be required to pay a liquidated damages sum to the other party of US\$40 million (noting that there are a limited number of completion deliverables to be provided by Evolution).
- If completion does not occur, Evolution will need to consider alternative uses for, or ways to return the proceeds under the Equity Raising. Also, certain transaction costs such as indemnity, legal and advisory fees will still be payable by Evolution.

Due diligence risks

- Evolution undertook a due diligence investigation process in respect of the Transaction and was provided with the opportunity to review certain information provided by, or on behalf of, CMOC.
- While Evolution considers that this review was adequate in the circumstances, the information was largely provided by CMOC. Consequently, Evolution has not been able to verify the accuracy, reliability or completeness of all the information which was provided to it against independent data and there is no assurance that the due diligence conducted was conclusive and that all material issues and risks in respect of the Transaction have been identified.
- Some of the information provided to Evolution included forward looking statements. Whilst Evolution has been able to review and assess some of the foundations of the forward looking information relating to the Northparkes Mine, forward looking information can be unreliable and is based on assumptions that may prove to be incorrect or may change in the future, outside of the control of Evolution.

Integration risks

- An important factor which may impact the long-term success of Evolution is likely to be the successful integration of the Northparkes Mine as part of Evolution's broader asset portfolio. The Northparkes Mine has been established as effectively a standalone business and while some transitional support will be required following completion of the Transaction for the purposes of implementing the integration process, difficulties may be encountered in connection with this process which could result in the failure of Evolution to realise some of the anticipated benefits of the acquisition or could result in those benefits being realised later than expected.
- Responsibility for the management of the operations of the Northparkes Mine is to be transferred to Evolution after the completion of the Transaction. The methods adopted by Evolution in respect of operating the Northparkes Mine may differ from the methods employed prior to the implementation of the Transaction. This may result in revisions to reserves and resources, life of mines, methodology for calculating cash costs, production forecasts and exploration and development targets for the Northparkes Mine.

Joint Venture Participant risk

- The use of joint ventures is common in the mining exploration and production industry and serves as a means to mitigate the risk and associated costs of exploration, production and operational failures. However, failure of agreement or alignment with Evolution's joint venture partners for the Northparkes Mine (which, upon completion of the Transaction, will be SMM and SC) could have an adverse effect on Evolution's business, and its operational or financial performance. The failure of the joint venture partners to meet their funding commitments (primarily by way of cash calls) and to share costs and liabilities may result in increased costs to Evolution. Evolution is unable to predict the risk of financial failure or default by a joint venture partner (present or future).

Northparkes Mine environmental risk

- It is not unusual for contamination to exist on or under mine sites. CMOC has only disclosed limited information to Evolution in relation to the nature and extent of known or suspected contamination on the tenements that underlie the Northparkes Mine. Evolution will be liable for its 80% share of any historical environmental offences committed by the Northparkes JV. If, in the future, there are significant non-compliances and environmental issues at the Northparkes Mine, this may give rise to a risk of the Environment Protection Licence being varied, suspended or terminated.
- Mining and exploration projects of this nature are subject to rehabilitation and closure obligations. Rehabilitation and closure costs associated with mining operations are subject to change and there can be no assurance that the current estimates for rehabilitation and closure activities associated with the Northparkes Mine will not increase.

Claims against vendor

- Most disputes arising out of or relating to the Transaction will be referred to and finally resolved by arbitration administered by the International Chamber of Commerce. There may be practical challenges with seeking to bring a successful claim against the vendors as foreign entities and to actually enforcing against such entities irrespective of whether an arbitral award is granted in favour of Evolution. Accordingly, the ability to seek (and obtain) recourse against the vendors in the event of a claim under the Share Sale and Purchase Agreement may be limited and may adversely impact Evolution's operational or financial performance.

Title

- Interests in exploration and mining tenements in New South Wales are evidenced by the granting of licences, leases, permits or authorities. Each of the tenement comprising the Northparkes Mine has been granted for a specified term and carry conditions imposed under the tenements and relevant laws and regulations applying in New South Wales. Evolution could face penalties, lose title to or its interest in the mining leases and exploration licences, or any other tenements that may be acquired by Evolution in future, if such conditions are not met.
- Evolution has considered all title matters concerning the CMOC Participant's ownership of the tenements underlying the Northparkes Mine. Whilst to the best of its knowledge, the CMOC Participant's title to the tenements is in good standing, this should not be construed as a guarantee of title. The CMOC Participant's title may be affected by undetected defects in title, such as the reduction in size of the titles and other third party claims affecting the CMOC Participant's interests in the tenements. Minerals properties and the leases associated with such properties sometimes contain claims or transfer histories that examiners cannot verify. A successful claim by a third party in relation to the tenements could cause Evolution to lose its rights to explore, develop and mine any minerals from the Northparkes Mine, without compensation for any prior expenditures incurred by Evolution or have other adverse financial consequences.

KEY RISKS - TRANSACTION

Employees

- The day-to-day operation of the Northparkes Mine is to a significant degree dependent upon the efforts of senior leadership personnel. While Evolution has every intention for the existing senior leadership team and workforce to remain employed following completion of the Transaction, if one or more of the senior leadership personnel ceases their employment there can be no assurances that would be no detrimental impact on Evolution's operational performance at the Northparkes Mine.

Assignment and change of control risks

- Some of the services contracts or other commercial arrangements with respect to the Northparkes Mine may contain assignment clauses, change of control clauses or similar/other provisions that may be triggered by the Transaction. If the relevant counterparties do not provide the necessary consents (or waivers), then this may result in the termination of the applicable arrangements, the suspension of services or supplies under them or contractual damages or other payments. This may have an adverse effect on the operating performance of the Northparkes Mine and, in turn, Evolution's operational and/or financial performance.

Inherited liabilities

- If the Transaction completes, Evolution may become directly or indirectly liable for liabilities that have been incurred by or in relation to the Northparkes Mine, and in respect of which the warranties and indemnities in favour of Evolution (or its subsidiaries) under the Share Sale and Purchase Agreement are not ultimately adequate (in terms of compensating Evolution for the financial or other impacts of such liabilities). Such liabilities may have an adverse effect on Evolution's operational or financial performance.

Risks associated with failure to realise benefits of the Transaction

- After completion of the Transaction, Evolution will seek to pursue those strategies, operational objectives and benefits set out in this presentation and the accompanying ASX announcement. There is the risk that Evolution may be unable to realise these strategies, operational objectives and benefits (in whole or in part) or that they will not materialise or will not materialise to the extent that Evolution anticipates. Any failure to meet these strategies, operational objectives and benefits could have an adverse effect on Evolution's operational or financial performance, and the return on its investment in the Northparkes Mine.

Offtake Agreement

- On completion of the Transaction, Evolution will enter into the Offtake Agreement. Given the Offtake Agreement will have a term referable to the existing reserves of the Northparkes Mine, it will be Evolution's sole source of revenue in relation to its investment in the Northparkes Mine. As with all contracts, there is a risk that the offtake party may not perform its obligations or may breach the Offtake Agreement. There is also a risk that the offtake party may become insolvent or may not be able to meet its future buying obligations under the Offtake Agreement. In these circumstances, Evolution would need to consider alternative arrangements for the sale of the copper concentrate produced from the Northparkes Mine. This could have an adverse affect on Evolution's financial performance and return on its investment in the Northparkes Mine.

Triple Flag Agreement

- Evolution will become a party to a Metal Purchase and Sale Agreement with Triple Flag International Ltd (Triple Flag), under which Triple Flag paid an upfront cash payment of US\$550 million and provides on-going payments equal to 10% of the spot gold price and spot silver price at the time of delivery for gold and silver equal to 54.0% of the gold and 80.0% of the silver produced at the Northparkes Mine. Depending on fluctuations in the price of gold and silver, Evolution's returns on its investment in the Northparkes Mine may be adversely affected.
- Evolution's proposed timing for completion of the Transaction could be delayed in certain circumstances as a consequence of the arrangements under the Metal Purchase and Sale Agreement with Triple Flag.

Tax Risks

- Evolution may become liable for additional tax liabilities as a result of the Transaction, including in relation to the Triple Flag Stream and any other assets acquired from CMOC.
- Evolution cannot guarantee any particular tax treatment of the Transaction nor of taxes imposed following completion of the Transaction. It is possible that this may be adverse to Evolution's operational and / or financial performance post-Transaction.

KEY RISKS - INVESTMENTS

Dividends

- Any future determination as to the payment of dividends by Evolution will be at the discretion of the Directors and will depend on the financial condition of Evolution, future capital requirements and general business and other factors considered relevant by the Directors. No assurance in relation to the continued or future payment of dividends or franking credits attaching to dividends can be given by Evolution.

Share market conditions

- Share market conditions may affect the value of Evolution's quoted shares regardless of Evolution's operating performance. Share market conditions are affected by many factors such as:
 - general economic outlook;
 - introduction of tax reform or other new legislation;
 - interest rates and inflation rates;
 - commodity prices;
 - foreign exchange markets;
 - changes in investor sentiment toward particular market sectors;
 - the demand for, and supply of, capital;
 - occurrence of pandemics (such as COVID-19); and
 - terrorism, geopolitical conflicts (including hostilities between Ukraine and Russia or in Israel and the Gaza territory) or other hostilities.
- The market price of shares can fall as well as rise and may be subject to varied and unpredictable influences on the market for equities in general and resource exploration stocks in particular. Neither Evolution nor the Directors warrant the future performance of Evolution or any return on an investment in Evolution.

Accounting standards may change

- Accounting standards may change. This may affect the reported earnings of Evolution and its financial position from time to time. Evolution has previously and will continue to assess and disclose, when known, the impact of adopting new accounting standards in its periodic financial reporting.

Force majeure events may occur

- Acts of terrorism, an outbreak of international hostilities or fires, floods, earthquakes, labour strikes, civil wars and other natural disasters may cause an adverse change in investor sentiment with respect to Evolution specifically or the share market more generally, which could have a negative impact on the value of an investment in Evolution shares.

Dilution risk

- Existing shareholders who do not participate in the Placement or the SPP will have their percentage shareholding in Evolution diluted. Depending on the size of a shareholder's existing holding, a participating shareholder may still be diluted even though they participate in the Placement or the SPP depending on the number of New Shares allocated to them.



APPENDIX: UNDERWRITING AGREEMENT

UNDERWRITING AGREEMENT (1/2)

Evolution has entered into an underwriting agreement with the underwriter (the **Underwriter**) in respect of the Placement dated 5 December 2023 (**Underwriting Agreement**), pursuant to which the Underwriter has agreed to fully underwrite the Placement on the terms and conditions of the Underwriting Agreement. The Underwriting Agreement contains customary conditions precedent, representations, warranties, undertakings and indemnities in favour of the Underwriter.

The Underwriter may terminate its obligations under the Underwriting Agreement on the occurrence of certain events without cost or liability at any time before 3.00pm on the settlement date for the Placement (expected to be 5 December 2023). Those events include (but are not limited to) where:

- (a) the Transaction agreement is:
 - I. terminated, rescinded, repudiated or released;
 - II. varied or amended in any material respect without the prior written consent of the Underwriter (such consent not to be unreasonably withheld or delayed in specified circumstances); or
 - III. any condition precedent to performance of the parties' obligations under the Transaction agreement becomes incapable of being satisfied within the time allowed for satisfaction;
- (b) the debt funding documents are:
 - I. terminated, rescinded, repudiated or released;
 - II. varied or amended in any material respect without the prior written consent of the Underwriter (not to be unreasonably withheld or delayed); or
 - III. any condition precedent to performance of the parties' obligations under the debt funding documents becomes incapable of being satisfied within the time allowed for satisfaction;
- (c) ASIC:
 - I. makes an application for an order under Part 9.5 of the Corporations Act in relation to the Placement, and any such application becomes public or (with respect to any application that is made following the bookbuild closing time only) is not withdrawn within 2 business days after it is made or where it is made less than 2 business days before the settlement date it has not been withdrawn before 8.00am on the settlement date;
 - II. commences, or gives notice of its intention to commence, any investigation or hearing under Part 3 of the *Australian Securities and Investments Commission Act 2001* (Cth) in relation to the Placement and any such investigation or hearing (or intention) becomes public or is not withdrawn within 2 business days after it is commenced or where it is commenced less than 2 business days before the settlement date it has not been withdrawn before 8.00am on the settlement date; or
 - III. otherwise issues proceedings in relation to the Placement or commences any formal inquiry or investigation into the Placement and any such issue becomes public or (with respect to an issue that is made following the bookbuild closing time only) is not withdrawn within 2 business days after it is made or where it is made less than 2 business days before the settlement date it has not been withdrawn before 8.00am on the settlement date;
- (d) ASX announces that the shares will be delisted, removed from quotation, withdrawn from admission to trading status or suspended from quotation (which, for the avoidance of doubt, does not include a trading halt requested to facilitate the Placement);
- (e) ASX notifies Evolution or the Underwriter that unconditional approval (or approval conditional only on customary conditions which are acceptable to the Underwriter, acting reasonably) will not be granted to the official quotation of all of the New Shares under the Placement on ASX or if granted, the approval is subsequently withdrawn, qualified (other than by customary conditions) or withheld;
- (f) Evolution withdraws the Placement;
- (g) any event specified in the Placement timetable is delayed for one business day or more without the prior approval of the Underwriter (other than any delay which is solely attributable to the acts or omissions of the Underwriter);
- (h) a certificate, which is required to be furnished by Evolution under the Underwriting Agreement, is not furnished when required;
- (i) any written materials that are presented or provided to investors or other documents relating to the Placement include content that is untrue, inaccurate, misleading or deceptive or likely to mislead or deceive (whether by inclusion or omission) in each case in a manner that is materially adverse from the perspective of investors in the Placement, or the documents relating to the Placement (including this presentation or any such ASX announcements) omit any information they are required to contain under applicable law;
- (j) an obligation arises on Evolution to give ASX a notice in accordance with section 708A(9) of the Corporations Act;
- (k) Evolution, or any of its related bodies corporate that represents in excess of 5% of the consolidated assets or earnings of the Evolution group, is or becomes insolvent or there is an act or omission which is likely to result in such member of the Evolution group becoming insolvent;
- (l) a director of Evolution:
 - I. is charged with an indictable offence or any regulatory body commences any public action against the director or announces that it intends to take any such action; or
 - II. is disqualified from managing a corporation under certain provisions of the Corporations Act;
- (m) there is an event or occurrence, including any statute, order, rule, regulation, directive or request (including one compliance with which is in accordance with the general practice of persons to whom the directive or request is addressed) of any governmental authority which makes it illegal for the Underwriter to satisfy an obligation under the Underwriting Agreement; or
- (n) Evolution or any of its directors or officers engage in or are charged in relation to any fraudulent conduct or activity whether or not in connection with the Placement.

UNDERWRITING AGREEMENT (2/2)

In addition, the Underwriter may terminate its obligations under the Underwriting Agreement on the occurrence of any of the following events during the same period as above, provided that it has reasonable grounds to believe and does believe that the event has had, or is likely to have, a materially adverse effect on the outcome or success or settlement of the Placement or on the ability of the Underwriter to settle the Placement, or the event could give rise to or result in a contravention or involvement in a contravention by the Underwriter or one of its affiliates of, or liability for the Underwriter or one of its affiliates under, the Corporations Act or any applicable law:

- (a) there is an omission from or misstatement relating to the completed questionnaire provided by Evolution or any other information supplied by or on behalf of Evolution to the Underwriter;
- (b) Evolution fails to perform or observe any of its obligations (including, for the avoidance of doubt, undertakings) under the Underwriting Agreement;
- (c) any representation or warranty made or given by Evolution in the Underwriting Agreement is or becomes misleading or deceptive, or is not true or correct at the relevant time;
- (d) a certificate, which is required to be furnished by Evolution under the Underwriting Agreement, when given is untrue, incorrect or misleading or deceptive (including by omission);
- (e) there is introduced, or there is a public announcement of a proposal to introduce, into the Parliament of the Commonwealth of Australia or any State or Territory of Australia a law or any new regulation is made under any law, or the Reserve Bank of Australia or a governmental authority adopts a policy (other than a law, regulation, or policy which has been announced prior to the date of the Underwriting Agreement) which affects or regulates the Placement or its settlement or the issue of the New Shares;
- (f) a change to:
 - I. the CEO or the CFO of Evolution occurs; or
 - II. the board of directors of Evolution occurs that has, or is likely to have, a materially adverse effect on:
 - 1. the success, marketing or settlement of the Placement; or
 - 2. the willingness of investors to subscribe for or settle New Shares;
- (g) Evolution or any of its related bodies corporate is in breach of any debt covenant;
- (h) there is an outbreak of hostilities not existing as at the date of the Underwriting Agreement or a major escalation of hostilities existing as at the date of the Underwriting Agreement (in each case, whether war is declared or not) involving any one or more of Australia, the United Kingdom, the United States, Israel, Gaza, Russia or Iran, or the declaration by any of these countries of a national emergency or war, or a significant terrorist attack is perpetrated in any of those countries or any diplomatic, military, commercial or political establishment of any of these countries;
- (i) any of the following occurs:
 - I. a general moratorium on commercial banking activities in Australia, the United Kingdom or the United States is declared by the relevant central banking authority in those countries, or there is a material disruption in commercial banking or security settlement or clearance services in any of those countries; or
 - II. trading in all securities quoted or listed on ASX, the London Stock Exchange or the New York Stock Exchange is suspended or limited in a material respect for one day on which the exchange is open for trading or substantially all of one day on which the exchange is open for trading;
 - III. any adverse change or disruption to the existing financial markets, political or economic conditions of Australia, the United Kingdom or the United States; or
- (j) any adverse change occurs in the assets, liabilities, financial position or performance, profits, losses or prospects of Evolution and its related bodies corporate (insofar as the position in relation to an entity in the Evolution group affects the overall position of Evolution), including any adverse change in the assets, liabilities, financial position or performance, profits, losses or prospects of Evolution or its related bodies corporate from those respectively disclosed in any Placement document, ASX announcement or any other materials provided to investors relating to the Placement.

Termination of the Underwriting Agreement by the Underwriter will discharge the Underwriter's obligations in respect of the period prior to termination and discharge Evolution's obligation to pay the Underwriter any fees, costs, charges or expenses which have not accrued as at termination, but the termination of its obligations will not limit or prevent the exercise of any other rights or remedies which any of the parties may otherwise have.

For details of the fees payable to the Underwriter, refer to the Appendix 3B released to the ASX on the date of this Presentation.



APPENDIX: INTERNATIONAL OFFERING RESTRICTIONS

INTERNATIONAL OFFERING RESTRICTIONS (1/3)

International Selling Restrictions

This document does not constitute an offer of New Shares of the Company in any jurisdiction in which it would be unlawful. In particular, this document may not be distributed to any person, and the New Shares may not be offered or sold, in any country outside Australia except to the extent permitted below.

Bermuda

This document has not been registered or filed with any regulatory authority in Bermuda. The offering of the New Shares pursuant to this document to persons resident in Bermuda is not prohibited, provided such offering does not constitute the carrying on of business in Bermuda by any person.

Brazil

The New Shares may not be offered or sold in Brazil, except in circumstances that do not constitute a public offering or unauthorized distribution under Brazilian laws and regulations. The New Shares have not been, and will not be, registered with the Comissão de Valores Mobiliários.

Canada (British Columbia, Ontario and Quebec)

New Shares are being offered only in the Provinces of British Columbia, Ontario and Quebec (the "**Provinces**") and to those persons to whom they may be lawfully distributed in the Provinces, and only by persons permitted to sell such Shares. This document is not, and under no circumstances is to be construed as, an advertisement or a public offering of securities in the Provinces. This document may only be distributed in the Provinces to persons that are "accredited investors" within the meaning of NI 45-106 – Prospectus Exemptions of the Canadian Securities Administrators.

No securities commission or similar authority in the Provinces has reviewed or in any way passed upon this document, the merits of the New Shares or the offering of New Shares and any representation to the contrary is an offence.

No prospectus has been, or will be, filed in the Provinces with respect to the offering of New Shares or the resale of such securities. Any person in the Provinces lawfully participating in the offer will not receive the information, legal rights or protections that would be afforded had a prospectus been filed and receipted by the securities regulator in the applicable Province. Furthermore, any resale of the New Shares in the Provinces must be made in accordance with applicable Canadian securities laws, which may require resales to be made in accordance with exemptions from dealer registration and prospectus requirements. These resale restrictions may in some circumstances apply to resales of the New Shares outside Canada and, as a result, Canadian purchasers should seek legal advice prior to any resale of the New Shares.

The Company as well as its directors and officers may be located outside Canada and, as a result, it may not be possible for purchasers to effect service of process within Canada upon the Company or its directors or officers. All or a substantial portion of the assets of the Company and such persons may be located outside Canada and, as a result, it may not be possible to satisfy a judgment against the Company or such persons in Canada or to enforce a judgment obtained in Canadian courts against the Company or such persons outside Canada.

Statutory rights of action for damages and rescission. Securities legislation in certain of the Provinces may provide purchasers with, in addition to any other rights they may have at law, rights of rescission or to damages, or both, when an offering memorandum that is delivered to purchasers contains a misrepresentation. These rights and remedies must be exercised within prescribed time limits and are subject to the defenses contained in applicable securities legislation. Prospective purchasers should refer to the applicable provisions of the securities legislation of their respective Province for the particulars of these rights or consult with a legal adviser.

Certain Canadian income tax considerations. Prospective purchasers of the New Shares should consult their own tax adviser with respect to any taxes payable in connection with the acquisition, holding, or disposition of the Shares as any discussion of taxation related matters in this document is not a comprehensive description and there are a number of substantive Canadian tax compliance requirements for investors in the Provinces.

Language of documents in Canada. Upon receipt of this document, each investor in Canada hereby confirms that it has expressly requested that all documents evidencing or relating in any way to the sale of the New Shares (including for greater certainty any purchase confirmation or any notice) be drawn up in the English language only. Par la réception de ce document, chaque investisseur canadien confirme par les présentes qu'il a expressément exigé que tous les documents faisant foi ou se rapportant de quelque manière que ce soit à la vente des valeurs mobilières décrites aux présentes (incluant, pour plus de certitude, toute confirmation d'achat ou tout avis) soient rédigés en anglais seulement.

Cayman Islands

The Company is not licensed to conduct investment business in the Cayman Islands by the Cayman Islands Monetary Authority and this document does not constitute a public offer of the New Shares, whether by way of sale or subscription, in the Cayman Islands. The New Shares have not been offered or sold, and will not be offered or sold, directly or indirectly, in the Cayman Islands.

European Union

This document has not been, and will not be, registered with or approved by any securities regulator in the European Union. Accordingly, this document may not be made available, nor may the New Shares be offered for sale, in the European Union except in circumstances that do not require a prospectus under Article 1(4) of Regulation (EU) 2017/1129 of the European Parliament and the Council of the European Union (the "**Prospectus Regulation**"). In accordance with Article 1(4)(a) of the Prospectus Regulation, an offer of New Shares in the European Union is limited to persons who are "qualified investors" (as defined in Article 2(e) of the Prospectus Regulation).

INTERNATIONAL OFFERING RESTRICTIONS (2/3)

Hong Kong

WARNING: This document has not been, and will not be, registered as a prospectus under the Companies (Winding Up and Miscellaneous Provisions) Ordinance (Cap. 32) of Hong Kong, nor has it been authorised by the Securities and Futures Commission in Hong Kong pursuant to the Securities and Futures Ordinance (Cap. 571) of the Laws of Hong Kong (the "SFO"). No action has been taken in Hong Kong to authorise or register this document or to permit the distribution of this document or any documents issued in connection with it. Accordingly, the New Shares have not been and will not be offered or sold in Hong Kong other than to "professional investors" (as defined in the SFO and any rules made under that ordinance).

No advertisement, invitation or document relating to the New Shares has been or will be issued, or has been or will be in the possession of any person for the purpose of issue, in Hong Kong or elsewhere that is directed at, or the contents of which are likely to be accessed or read by, the public of Hong Kong (except if permitted to do so under the securities laws of Hong Kong) other than with respect to New Shares that are or are intended to be disposed of only to persons outside Hong Kong or only to professional investors.

No person allotted New Shares may sell, or offer to sell, such securities in circumstances that amount to an offer to the public in Hong Kong within six months following the date of issue of such securities.

The contents of this document have not been reviewed by any Hong Kong regulatory authority. You are advised to exercise caution in relation to the offer. If you are in doubt about any contents of this document, you should obtain independent professional advice.

Japan

The New Shares have not been and will not be registered under Article 4, paragraph 1 of the Financial Instruments and Exchange Law of Japan (Law No. 25 of 1948), as amended (the "FIEL") pursuant to an exemption from the registration requirements applicable to a private placement of securities to Qualified Institutional Investors (as defined in and in accordance with Article 2, paragraph 3 of the FIEL and the regulations promulgated thereunder) pursuant to an exemption from the registration requirements applicable to a private placement of securities to Qualified Institutional Investors. Accordingly, the New Shares may not be offered or sold, directly or indirectly, in Japan or to, or for the benefit of, any resident of Japan other than Qualified Institutional Investors. Any Qualified Institutional Investor who acquires New Shares may not resell them to any person in Japan that is not a Qualified Institutional Investor, and acquisition by any such person of New Shares is conditional upon the execution of an agreement to that effect.

New Zealand

This document has not been registered, filed with or approved by any New Zealand regulatory authority under the Financial Markets Conduct Act 2013 (the "FMC Act").

The New Shares may only be offered or sold in New Zealand (or allotted with a view to being offered for sale in New Zealand) to a person who:

- is an investment business within the meaning of clause 37 of Schedule 1 of the FMC Act;
- meets the investment activity criteria specified in clause 38 of Schedule 1 of the FMC Act;
- is large within the meaning of clause 39 of Schedule 1 of the FMC Act;
- is a government agency within the meaning of clause 40 of Schedule 1 of the FMC Act; or
- is an eligible investor within the meaning of clause 41 of Schedule 1 of the FMC Act.

Norway

This document has not been, and will not be, registered with or approved by Finanstilsynet (the Financial Supervisory Authority of Norway) and it does not constitute a prospectus under the Prospectus Regulation (Regulation (EU) 2017/1129) or the Norwegian Securities Trading Act of 29 June 2007 no. 75. Accordingly, this document may not be made available, nor may the New Shares be offered for sale, directly or indirectly, in Norway other than under circumstances that are exempted from the prospectus requirements under the Prospectus Regulation and the Norwegian Securities Trading Act. Any offering of New Shares in Norway is limited to persons who are "qualified investors" as defined in the Prospectus Regulation. Only such persons may receive this document and they may not distribute it or the information contained in it to any other person.

Singapore

This document and any other materials relating to the New Shares have not been, and will not be, lodged or registered as a prospectus in Singapore with the Monetary Authority of Singapore. Accordingly, this document and any other document or materials in connection with the offer or sale, or invitation for subscription or purchase, of New Shares, may not be issued, circulated or distributed, nor may the New Shares be offered or sold, or be made the subject of an invitation for subscription or purchase, whether directly or indirectly, to persons in Singapore except pursuant to and in accordance with exemptions in Subdivision (4) of Division 1, Part 13 of the Securities and Futures Act 2001 of Singapore (the "SFA"), or as otherwise pursuant to, and in accordance with the conditions of any other applicable provisions of the SFA. This document has been given to you on the basis that you are (i) an existing holder of securities in the Issuer, (ii) an "institutional investor" (as defined under Section 4A(1)(c) of the SFA) or (iii) an "accredited investor" (as defined in Section 4A(1)(a) of the SFA). In the event that you are not an investor falling within any of the categories set out above, please return this document immediately. You may not forward or circulate this document to any other person in Singapore. Any offer is not made to you with a view to the New Shares being subsequently offered for sale to any other party. There are on-sale restrictions in Singapore that may be applicable to investors who acquire the New Shares. As such, investors are advised to acquaint themselves with the SFA provisions relating to resale restrictions in Singapore and comply accordingly.

Switzerland

This document is not intended to constitute an offer or solicitation to purchase or invest in the New Shares described herein. The New Shares may not be publicly offered, sold or advertised, directly or indirectly, in, into or from Switzerland but may be offered to individually approached professional investors as defined in article 4 of the Swiss Financial Services Act ("FinSA") and no application has been or will be made to admit the New Shares to trading on any trading venue (exchange or multilateral trading facility) in Switzerland. Neither this document nor any other offering or marketing material relating to the New Shares constitutes a prospectus pursuant to the FinSA, and neither this document nor any other offering or marketing material relating to the New Shares may be publicly distributed or otherwise made publicly available in, into or from Switzerland.

Neither this document nor any other offering or marketing material relating to the offering of the New Shares has been or will be filed with or approved by any Swiss regulatory authority or any review body.

This document is personal to the recipient only and not for general circulation in Switzerland.

INTERNATIONAL OFFERING RESTRICTIONS (3/3)

United Arab Emirates

The New Shares have not been, and are not being, publicly offered, sold, promoted or advertised in the United Arab Emirates other than in compliance with the laws of the United Arab Emirates governing the issue, offering and sale of securities. Further, this document does not constitute a public offer of securities in the United Arab Emirates and is not intended to be a public offer. This document has not been approved by or filed with the Central Bank of the United Arab Emirates, the Securities and Commodities Authority. No offer or invitation to subscribe for New Shares is valid, or permitted from any person, in the Abu Dhabi Global Market or the Dubai International Financial Centre.

United Kingdom

Neither this document nor any other document relating to the offer has been delivered for approval to the Financial Conduct Authority in the United Kingdom and no prospectus (within the meaning of section 85 of the Financial Services and Markets Act 2000, as amended ("**FSMA**")) has been published or is intended to be published in respect of the New Shares.

This document is issued on a confidential basis to "qualified investors" (as defined in Regulation (EU) 2017/1129 as it forms part of UK law by virtue of the European Union (Withdrawal) Act ("**UK Prospectus Regulation**")) in the United Kingdom, and the New Shares may not be offered or sold in the United Kingdom by means of this document, any accompanying letter or any other document, except in circumstances which do not require the publication of a prospectus pursuant to section 86(1) of the FSMA. This document should not be distributed, published or reproduced, in whole or in part, nor may its contents be disclosed by recipients to any other person in the United Kingdom.

Any invitation or inducement to engage in investment activity (within the meaning of section 21 of the FSMA) received in connection with the issue or sale of the New Shares has only been communicated or caused to be communicated and will only be communicated or caused to be communicated in the United Kingdom in circumstances in which section 21(1) of the FSMA does not apply to the Company.

In particular, this document is being distributed only to, and is directed at, persons who are qualified investors (as specified above) (i) who have professional experience in matters relating to investments falling within Article 19(5) (investment professionals) of the Financial Services and Markets Act 2000 (Financial Promotions) Order 2005 ("**FPO**"), (ii) who fall within the categories of persons referred to in Article 49(2)(a) to (d) (high net worth companies, unincorporated associations, etc.) of the FPO or (iii) to whom it may otherwise be lawfully communicated (together "**relevant persons**"). The investment to which this document relates is available only to relevant persons. Any person who is not a relevant person should not act or rely on this document.

United States

This document may not be distributed or released in the United States. This document does not constitute an offer to sell, or a solicitation of an offer to buy, any securities in the United States.

The New Shares have not been, and will not be, registered under the U.S. Securities Act of 1933 (the "**Securities Act**") and may not be offered or sold to, any person in the United States except pursuant to an exemption from, or in a transaction not subject to, the registration requirements of the Securities Act and applicable securities laws of any state or other jurisdiction of the United States. There will be no public offering of the New Shares in the United States.

Evolution

MINING